



Setti D. Warren
Mayor

Newton Parks & Recreation Commission
Meeting Minutes
City Hall, Room 209, 7:00pm
May 16, 2011



Robert J. DeRubeis
Commissioner

Attending: Arthur Magni, *Chairman*, Kathleen Heitman, *Vice-Chair*, Bob DeRubeis, *Commissioner*, Walter Bernheimer, Peter Johnson, Richard Tucker, Andrew Stern, Fran Rice, Don Fishman, Peter Kastner, Robin McLaughlin, *Secretary*

Absent: Bethel Charkoudian, Jack Neville, Michael Clarke

Meeting called to order at 7:03pm

1. Meeting Minutes –April 25, 2011

- Accepted 7-0 (Stern not voting)

2. Commissioner's Reports on Programs, Forestry and Maintenance

- **Department Snapshot** – Commissioner DeRubeis reviewed the department snapshot (attached) and current events:
 - Budget presented to the Programs & Services Committee- passed 6-0
 - Kids Fun Fest - April 30 & May 1
 - Special Athletes Ball- May 11
 - Newton Serves - May 15- out of 67 projects, P & R was directly involved with 40 projects
 - New Spring Farmers Market - Opens Tuesday, May 24 @ the Post 440
 - Canoe & Kayak rentals are open at Nahanton Park
 - Mayor's Prayer Breakfast - May 25
 - Newton Conservators 50th Anniversary Dinner - May 25
 - Gath Pool & Crystal Lake open June 13
- **Off-leash Area Working Group** – Commissioner DeRubeis reviewed a report submitted by the City Clerk regarding off-leash recreation medallions (attached):
 - 566 Resident medallions have been purchased.
 - 2 non-resident medallions have been purchased.
 - 3 Newton based professional dog walking company permits have been purchased.
 - Mr. Kastner asked if attendance at the Old Cold Spring Park off-leash area has gone down. Commissioner DeRubeis commented that Officer Torres has said the attendance has gone down at Old Cold Spring Park off-leash area.

3. Susan G. Komen 3 day for the cure event– McGrath Park – Public Hearing

- Jennifer Ricker, Event Coordinator presented a map (attached) of McGrath Park describing the route and layout for the lunch stop at McGrath Park on Friday July 22, 2011. Lasell College has been used for the lunch stop but Lasell is unavailable due to construction. There will be six tents, two food tents, two water tents and two medical tents. There will be 2-3 buses to transport people. The portable toilets will be brought in Thursday afternoon and will be removed by Friday afternoon. The lunch stop hours are from 11:15 am-2:45pm.

- Commissioner DeRubeis commented all of the items are located in the P & R parking area. Ms. Ricker stated yes there is no need to put the tents on the field; the participants will sit on the ground to eat their lunch.
- Chairman Magni asked if the participants will be on the field or driveway. Ms. Ricker stated they try to keep walkers out of driveways if possible.
- Mr. Stern asked if there would be any interference with the residents of Warren House. Ms. Ricker stated no.
- Ms. McGrath, Resident, stated her concern was the portable toilets being dropped off at 3am and left in the area disturbing the Warren House residents. Ms. Ricker stated the portable toilets will not be delivered at 3am but on Thursday afternoon.

Mr. Bernheimer made the motion to approve the Susan G. Komen 3 day for the cure event lunch stop at McGrath Park as proposed. Mr. Johnson seconded the motion. The motion passed 8-0.

4. Batting Cages – NCLL – Butch Matthews & Jim Appelbaum

- Mr. Matthews and Mr. Appelbaum are requesting permission to erect a temporary batting cage at Cabot Field along the third base line. The batting cage will not interfere with the kids from Cabot School. The structure is enclosed, comes apart easily and will not rust (see attached).
- Mr. Bernheimer asked when the batting cage would be put up and taken down. Mr. Matthews stated the batting cage would go up in the spring and come down in the fall.
- Mr. Stern asked where the batting cage would be stored. Mr. Appelbaum commented the batting cage would be stored at their contractor's office or in the storage units at Cabot.
- Mr. Matthews requested they be allowed to run electricity for a hitting machine.
- Mr. Stern asked if this would be a portable machine. Mr. Matthews stated yes, the machine would not be left in the batting cage.
- Ms. Heitman stated this is a great benefit for the children.
- Mr. Bernheimer asked when the batting cage would be installed. Mr. Appelbaum stated a.s.a.p., but the cage would take 4-6 weeks for delivery.
- Mr. Stern asked if there would be any signage. Mr. Matthew stated no, there would be no signage.

Mr. Stern made the motion to approve the batting cage subject to approval y the Engineering Department and the P & R Department to run the cable. Ms. Heitman seconded the motion. Motion passed 8-0.

5. New Business

- Youth Awards will be held at 7 pm in the Aldermanic Chambers on June 20th directly before the Commission meeting.

Meeting Adjourned at 7:40 pm

Respectfully submitted, *Robin McLaughlin, Secretary*

Department Snapshot – (one page)

Employee Attendance				
	Worker Days	Days Missed		Power Indicator
		Leave	Vacation	
Administration (5)	75	1	1.5	97%
Program (8)	120	1	1.5	98%
Grounds Maintenance (16)	225	26.5	4.5	86%
Urban Forestry (2)	30	0	5	83%
	450	28.5	12.5	91%

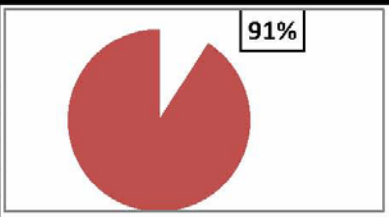

Customer Service Measures			
	Phone Calls	FAQ's Viewed	Total Inquires
Administration	312	77	389
Program	710	162	872
Facilities	139	87	226
Grounds Maintenance	42	0	42
Urban Forestry	163	524	687
totals	1366	850	2216

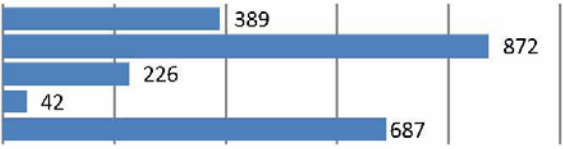

Service Requests			
Grounds Maintenance			Urban Forestry
	Rcv'd	closed	Avg. Age of Comp. (days)
School Dude	35	35	3
WebQA	9	6	42

	Rcv'd	Closed	Avg. Age of Comp. (days)
Pruning	31	0	na
Removals	29	0	na
Dn tr, lb, hngr	42	34	4
Inspect only	34		
Removal backlog	132	128	
Prune backlog	519	3102 (8.5 years)	

Financial Measures		
	Quant.	\$ Amount
Purchase Orders	26	\$ (31,475.17)
Invoices Paid	202	\$ (86,084.35)
Checks Processed	365	\$ 91,339.39
Cash Processed	6	\$ 983.00
Credit Cards Processed	360	\$ 109,314.25
	959	\$ 84,077.12

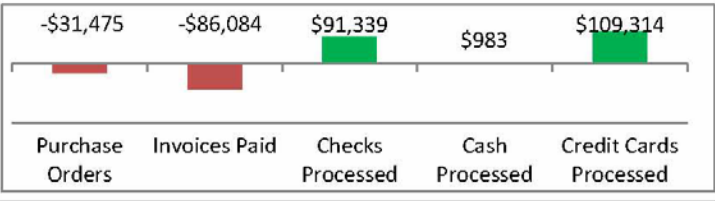

Key Project Updates					
Project	Lead	Total Cost		% done	
Burr Park	Lapham			50%	fund raising
Cheesecake Brook Imprv. Ph. II	Bailey/ Schein	\$20-\$30k		0%	
DEP Permit Nahanton Park Docks	Schein/Dore				
Drainage Swale @ Main Library	Daghlian/Stapleton	\$0.00		0%	
Farlow Pond Restoration	Lapham/Schein	\$40k		95%	
Hyde Park War Memorial	Mannion	\$21,450.00		15%	
Improvements to Lower Falls C.C.	Cabral/Dore	\$680k		75%	
Mason-Rice Play Ara	Lapham			68%	fund raising
Nat. Resource Nahanton Pk.	Schein/Dore	\$5,900.00			
Pellegrini	Cahill/Lapham/Schein			0%	
Taiwan Garden	Schein	privately		85%	
Tennis Backboard	Schein/Mannion	\$16,619.00		90%	

Program Attendance	
Total Program Attendance For Month	3853
Total Number of Programs For Month	43

*see reverse for program list and attendance

City

Clerk report – Off-leash recreation area medallions (one page)

Off-Leash Recreation Permit Program Information as of May 16, 2011.

Report of the Newton City Clerk

1. How many resident off-leash permits have been sold?

To date there have been 566 off-leash permits sold.

2. How many non-resident off-leash permits have been sold?

There have been 2 non-resident off-leash permits sold, both to individuals in Needham.

3. How many professional dog walker permits have been sold?

To date there have been 3 sold to Newton based companies.

4. Has any resident purchased their dog license while purchasing a medallion? Yes. There have been a few, but it is only about 8% of the total. The vast majority, 92%, of off-leash permits sold have been to owners who had already licensed their dogs

5. Do you see an increase in dog license compliance? We are seeing an increase in compliance; however, it is hard to say it is directly from the sale of off-leash permits. Only fifteen dog owners are both new to our licensing system and have purchased both a license and off-leash permit for the first time, since we started selling off-leash permits. We have been working hard over the last few years to bring the number of licensed dogs up with marketing and advertising, and the trend is continuing. We are on track to license 4,000 dogs this year.

* Year-to-date

6. Any other facts you think important. We have had a number of individuals who have licensed their dog state that

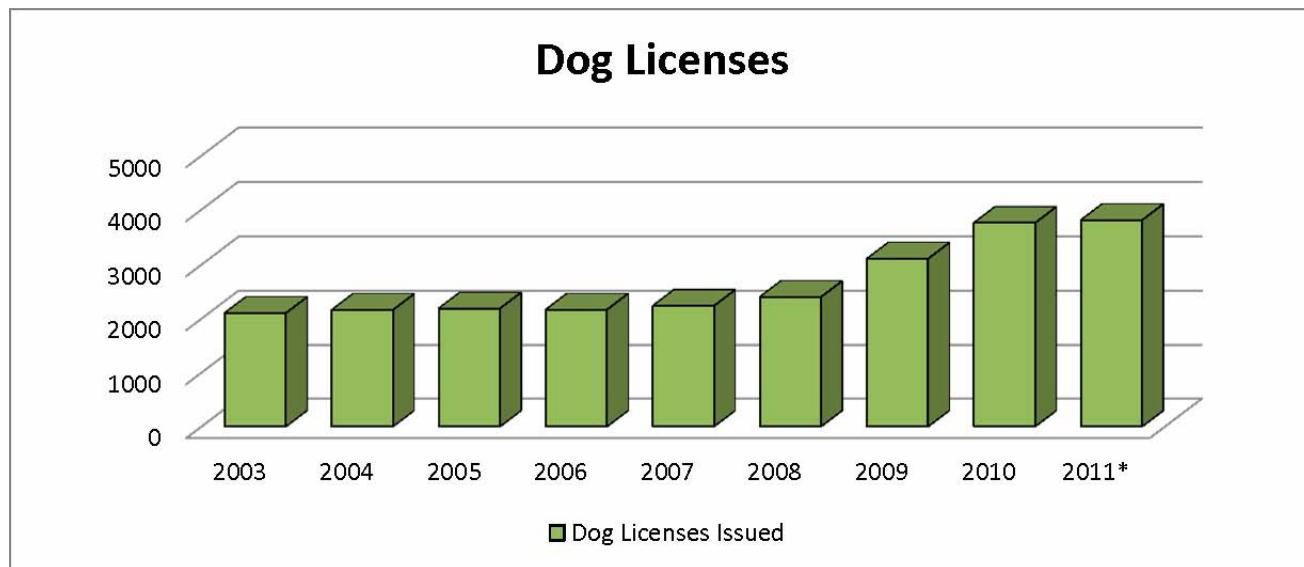

they were going to wait to purchase an off-leash permit until the fenced in areas were open.

Susan G. Komen 3 day for the cure event– McGrath Park

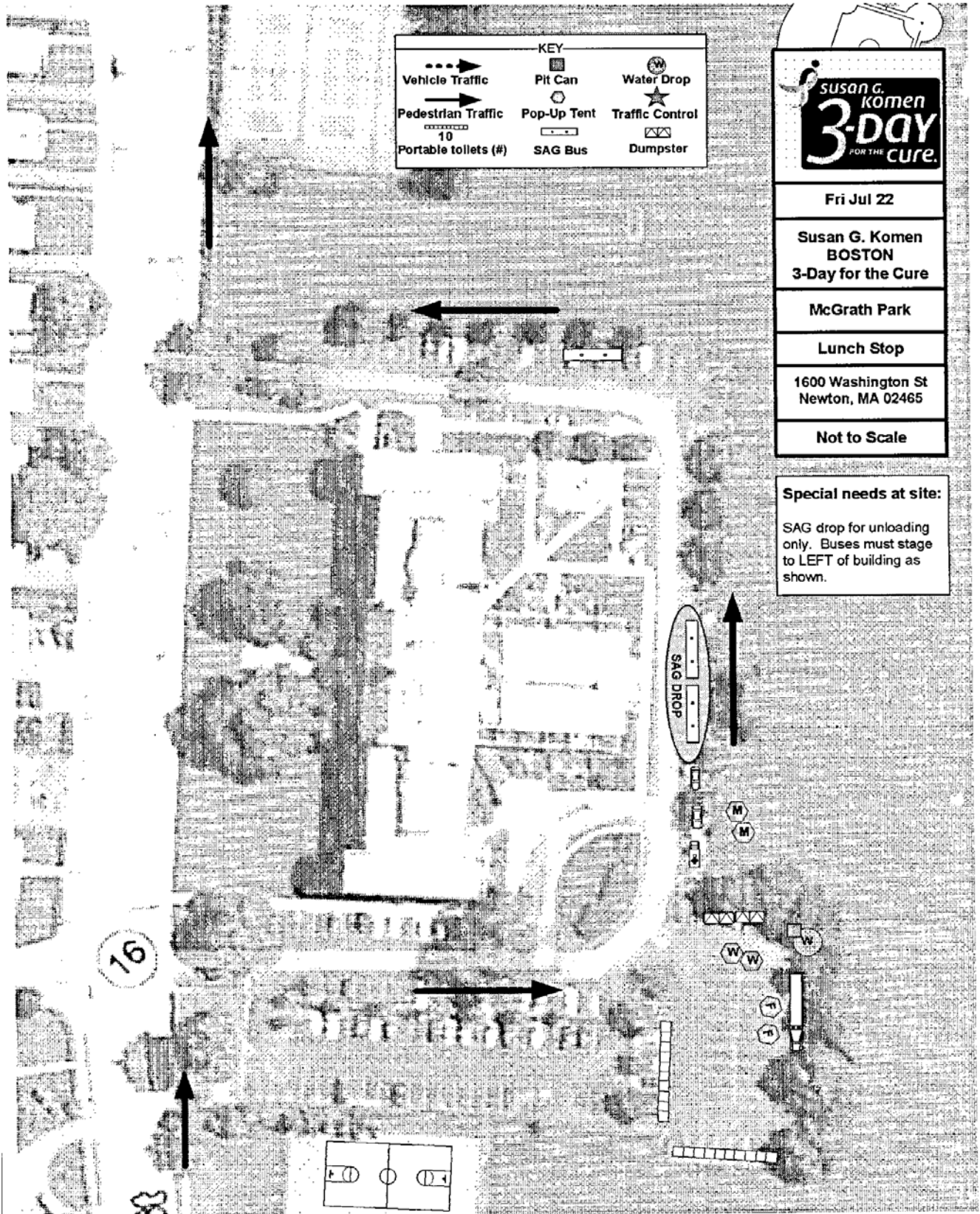

NCLL- Batting Cages (page 1 of 2)

★ BATTING TUNNEL FRAMES ★

NBC Indoor-Outdoor Free-Standing Batting Tunnel Frames are made of heavy duty galvanized steel. Our unique cable system is included when ordering the free-standing metal frame and batting tunnel combination. Frames can be ordered separately or with the net. No welding required.

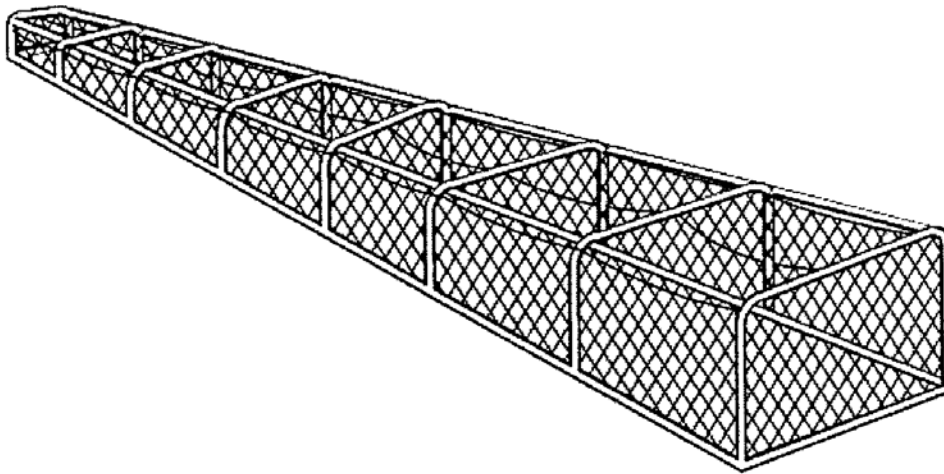

Net Dimensions	Frame Dimensions	#24 Twine	#30 Twine	#36 Twine	#42 Twine
12'H x 15'W x 50'L	12'H x 18'W x 54'L	\$4,075	\$4,195	\$4,305	\$4,425
12'H x 15'W x 60'L	12'H x 18'W x 64'L	\$4,375	\$4,515	\$4,645	\$4,785
12'H x 15'W x 70'L	12'H x 18'W x 74'L	\$4,695	\$4,825	\$4,985	\$5,135

NCLL- Batting Cages (page 2 of 2)

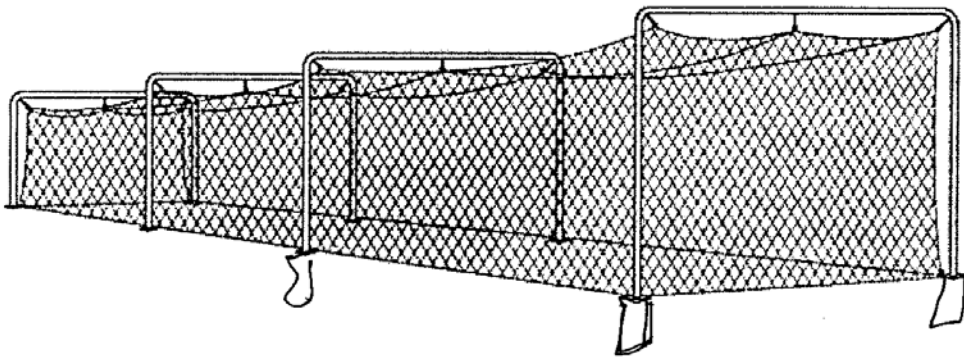

NBC Outdoor Batting Tunnel Frames are made of heavy-duty galvanized steel tubing. Supports can be installed permanently in the ground or made removable by inserting into a ground sleeve. When ordering the Batting Tunnel Net and Outdoor Batting Tunnel Frame at the same time, the cable system will cost \$100.00. Ground sleeves are available for \$25.00 each. Custom size frames are available for your present batting tunnel net. Call for quotes.

PERMANENT OR REMOVABLE

OF-2000	3 Support Frames	\$600
OF-2001	4 Support Frames	\$800
OF-2002	5 Support Frames	\$1000
OF-2003	6 Support Frames	\$1200

The length of net and twine determine the number of supports required to suspend your Batting Tunnel Net.

Batting Tunnel Nets sold separately. [Click here for Hitting Cage](#)

GROUND SLEEVES are available at an additional cost and allow for the removal of the frame during off-season storage.