

The Preservation and Restoration of Farlow Park



Newton's Oldest Park

- In 1880 philanthropist John Farlow donated a parcel of land to the City of Newton to establish an open space for recreation and relaxation.
- In 1883 George Frederick Meacham, the designer of Boston Public Gardens laid out a plan for Farlow Park.
- In 1885 City Engineer Albert F. Noyes took Meacham's plan and a plan by George Schinn which featured a baseball field, and drew up a plot plan.

Meacham's Boston Public Garden

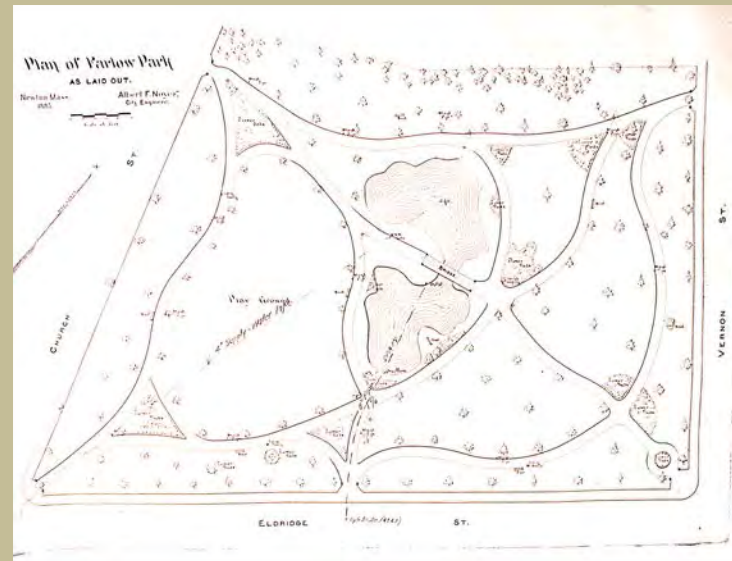
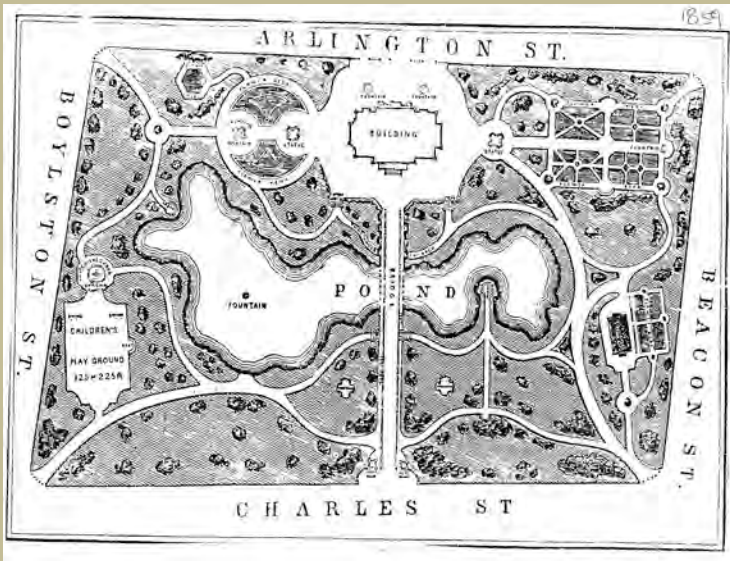

- Note the similarities of Boston Public Garden on the left and Farlow Park on the right.

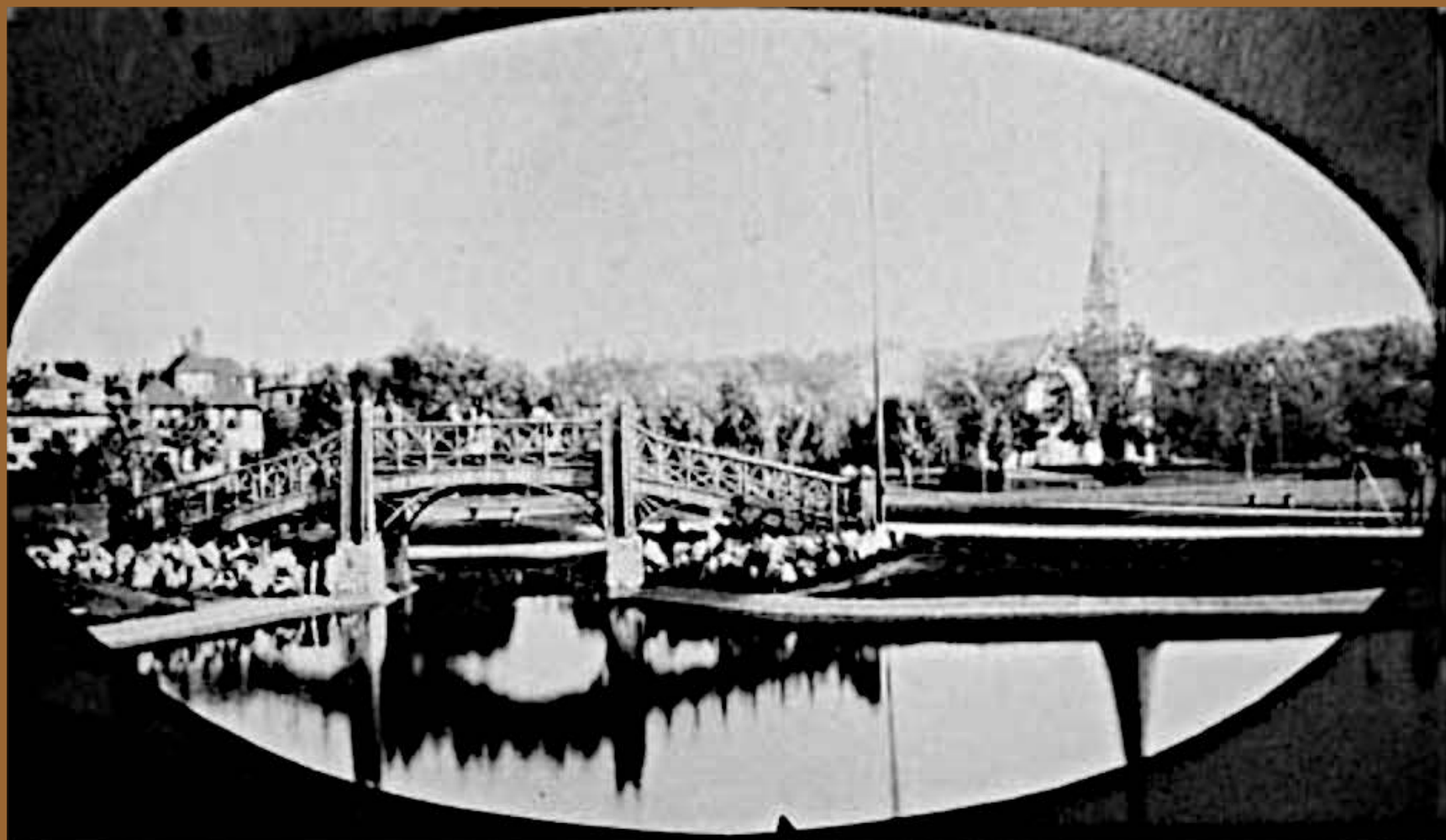

Farlow Park, Newton Corner, is seen here in 1888, shortly after the landscaping had been completed.



80003



Farlow Park, Newton, Mass.

9451



FARLOW PARK--RUSTIC BRIDGE NEWTON MASS





Farlow Park, Newton, Mass.





FARLOW – CHAFFIN PARK

HISTORIC PLANNING AND DESIGN

Landscape Restoration Report, June 2006



Prepared by
Brown, Richardson & Rowe, Inc.
Landscape Architects and Planners
with
Ammann & Whitney, Structural Engineers
CMS Collaborative, Fountain Consultants

Project funded by the Community Preservation Act





Restoration Map and recommendations, June 2006

Weston and Sampson Report 2011





Pond Shell Profile

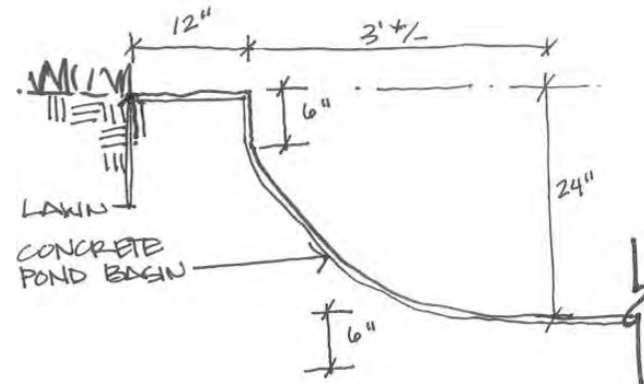

Newton Cemeteries



Newton City Hall

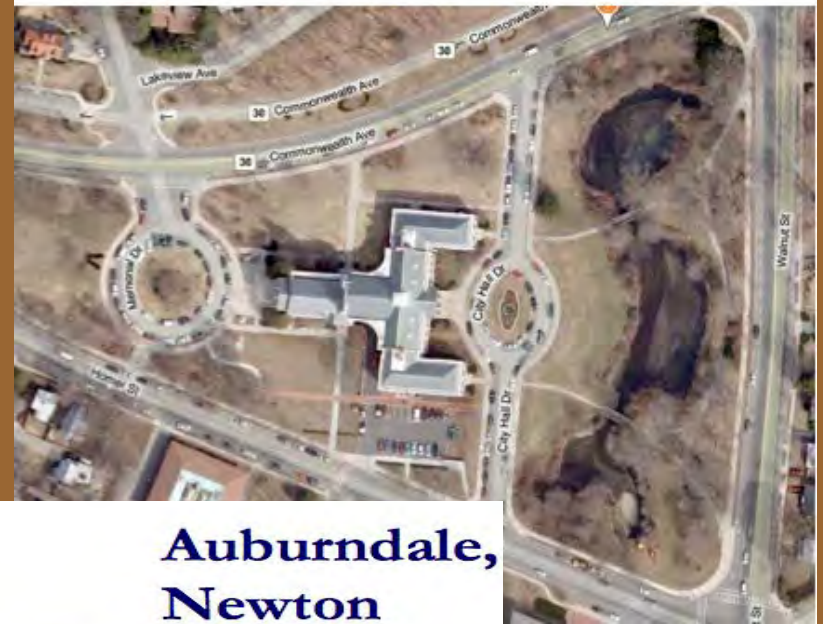

Auburndale, Newton





**Lars Anderson Park,
Brookline**



**Elm Park,
Worcester**

**Public Garden Lagoon,
Boston**



**Perkins School for the Blind,
Watertown**



Findings of Weston and Sampson Engineers, Inc.

- “Based upon the data gathered in the course of the year and extensive precedent studies conducted at similar features in public parks, near schools and playgrounds intended for young children, we have determined that the restoration of the Farlow Pond does not pose undue safety concerns.”
- We have established that well water “can be supplied to both the pond and irrigation systems for the adjacent ball field.”

Preliminary Design for Farlow Park Bridge

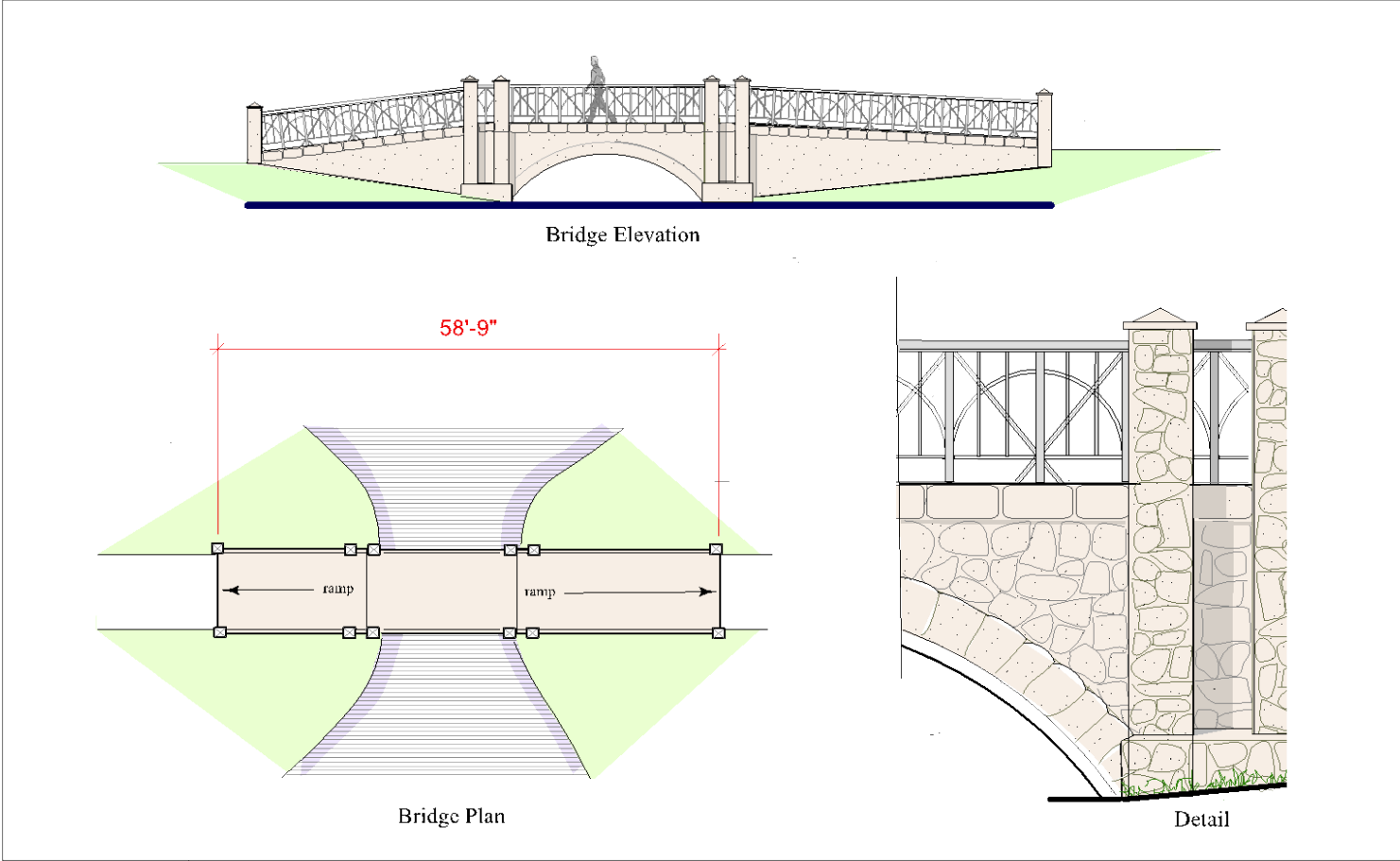

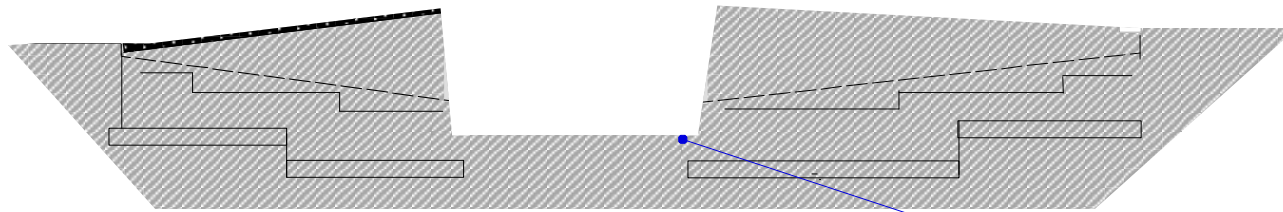
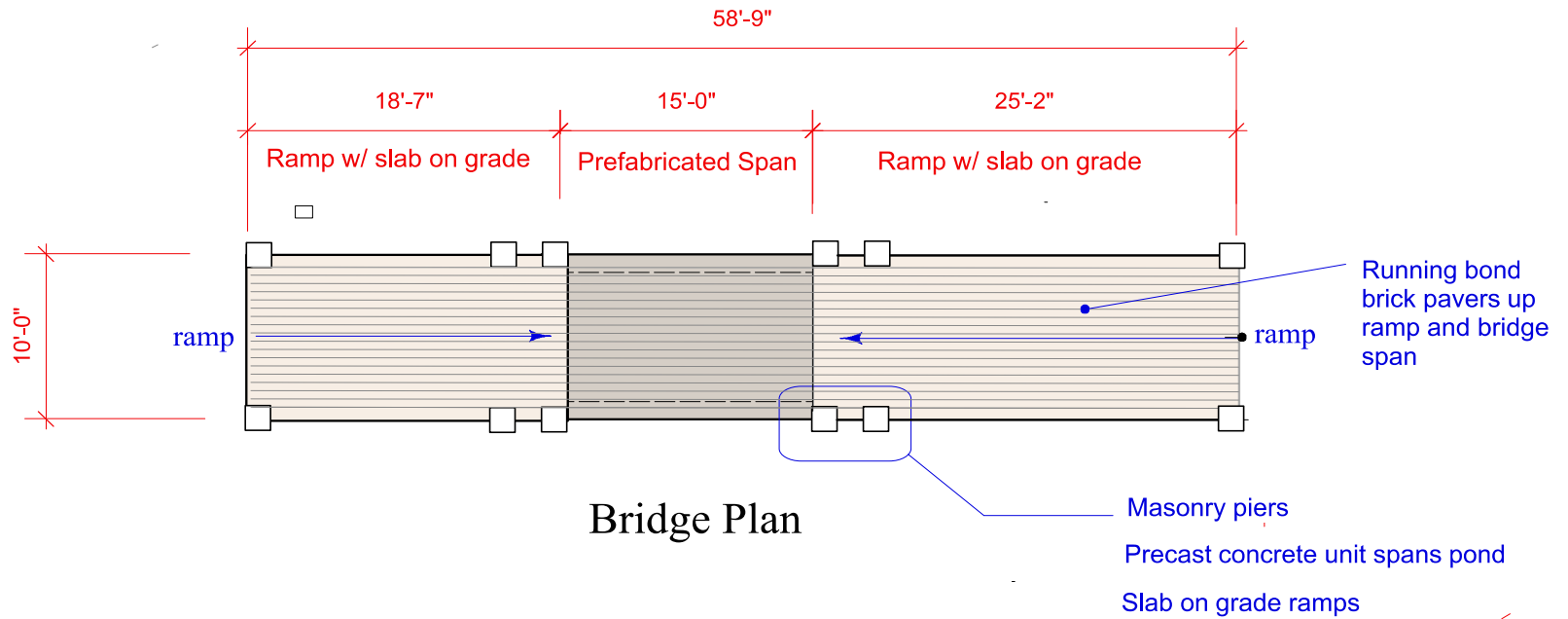

ation wall.

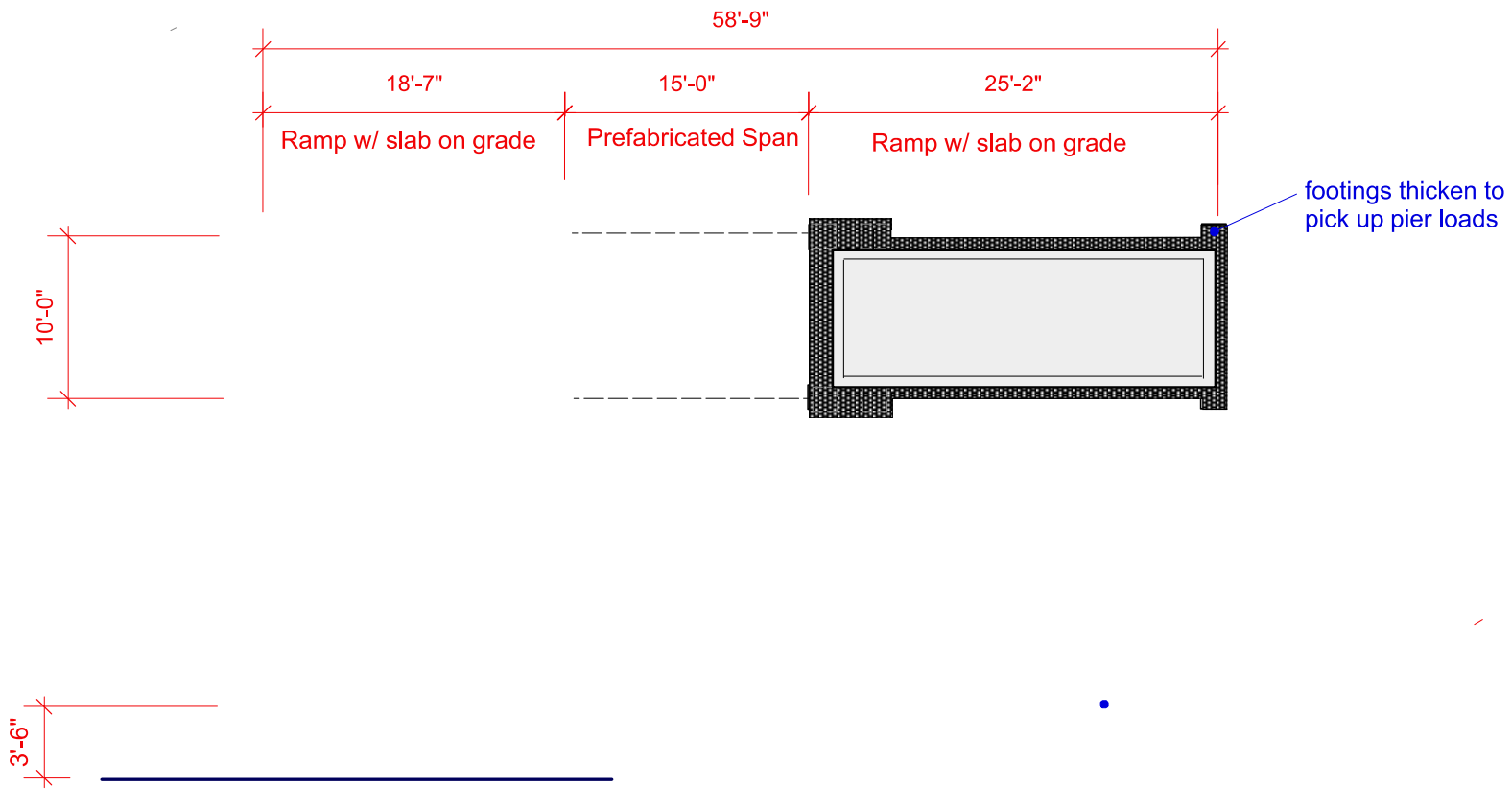

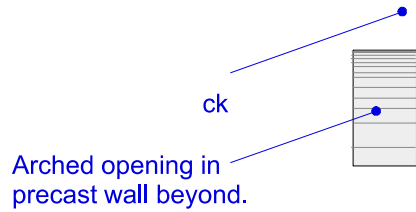

Section at Precast Span

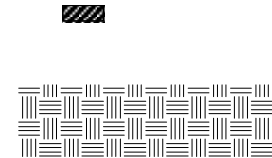

Section at ramp wall

Example of Stone Cladding for Farlow Bridge



New Irrigation system for Underwood School Playground

