



Finance Committee Agenda

City of Newton In City Council

RECEIVED
By Shawna Sullivan at 3:14 pm, Nov 16, 2017

Monday, November 20, 2017

6:15 PM
Room 211

Items scheduled for discussion:

#348-17 **Appropriate \$7,000 for police enforcement of accessible parking regulations**
HIS HONOR THE MAYOR requesting authorization to appropriate seven thousand dollars (\$7,000) from the Handicapped Parking Fine Fund to be used to pay for special police detail enforcement of the accessible parking regulations. [10/30/17 @ 2:12 PM]

Referred to Public Safety & Transportation and Finance Committees

#354-17 **Bond authorization for \$106,000 to upgrade computer equipment in police vehicles**
HIS HONOR THE MAYOR requesting authorization to appropriate and expend one hundred six thousand dollars (\$106,000) from bonded indebtedness for the purpose of upgrading the Toughbooks equipment in the Police Department's first line response vehicles. [10/30/17 @ 2:14 PM]
Public Safety & Transportation Approved 7-0 on 11/08/17

Referred To Public Facilities and Finance Committees

#320-17 **Request to construct fence around Rumford Avenue solar site**
COUNCILORS SANGIOLO, HARNEY AND GENTILE requesting that His Honor the Mayor take the necessary steps to construct a 9½' chain link fence with ivy around the exterior of the Rumford Avenue solar site. [09/29/17 @ 2:18 PM]
Public Facilities Approved 5-0 on 11/08/17

#343-17 **Accept a grant from Mass Housing to support the work of the Hoarding Task Force**
HIS HONOR THE MAYOR requesting authorization to accept and expend a grant from the Massachusetts Department of Housing for hoarding services in the amount of three thousand five hundred dollars (\$3,500) to support the work of the Newton Hoarding Task Force. [10/20/17 @ 9:46 AM]

#346-17 **Request to transfer funds for a 1-year collective bargaining agreement with AFSME**
HIS HONOR THE MAYOR requesting authorization to transfer the necessary funding the from Current Year Wage Reserve Account to various department budgets in order to fund the cost items set forth in the one-year labor contract agreement with the

The location of this meeting is accessible and reasonable accommodations will be provided to persons with disabilities who require assistance. If you need a reasonable accommodation, please contact the city of Newton's ADA Coordinator, Jini Fairley, at least two business days in advance of the meeting: ifairley@newtonma.gov or (617) 796-1253. The city's TTY/TDD direct line is: 617-796-1089. For the Telecommunications Relay Service (TRS), please dial 711.

American Federation of State, County and Municipal Employees (AFSME), City Hall Associates, Local 3092. [10/30/17 @ 2:17 PM]

- #349-17** **Appropriate \$41,080 from Inclusionary Zoning Funds to repay HOME funds**
HIS HONOR THE MAYOR requesting authorization to appropriate and expend forty-one thousand eighty dollars (\$41,080) from the Inclusionary Zoning Fund and the Newton Housing Authority will contribute an equal amount for the purpose of repaying HOME funds in the amount of \$82,160.

Referred to Public Facilities and Finance Committees

- #356-17** **Bond authorization for \$280,000 to purchase a Gradall for DPW**
HIS HONOR THE MAYOR requesting authorization to appropriate and expend two hundred eighty thousand dollars (\$280,000) from bonded indebtedness to purchase a Gradall vehicle for the Public Works Department. [10/30/17 @ 2:17 PM]
Public Facilities Approved 5-0 on 11/08/17

- #357-17** **Request to authorize a lease for software for the School Department**
HIS HONOR THE MAYOR requesting authorization for the city to enter into a lease agreement for the delivery, implementation, management, and support of the Student Information Systems (SIS) for the Newton Public Schools. [10/30/17 @ 2:15 PM]

Referred to Public Safety & Transportation and Finance Committees

- #355-17** **Bond authorization for \$1.2 million to replace Fire Ladder Truck #2**
HIS HONOR THE MAYOR requesting authorization to appropriate and expend one million two hundred thousand dollars (\$1,200,000) from bonded indebtedness to replace the Fire Department's Ladder Truck #2. [10/30/17 @ 2:17 PM]
Public Safety & Transportation Approved 7-0 on 11/08/17

- #345-17** **Accept a grant from MEMA for equipment for the Emergency Operations Center**
HIS HONOR THE MAYOR requesting authorization to accept and expend a grant from the Massachusetts Emergency Management Agency Grant in the amount of twenty-two thousand four hundred sixty dollars (\$22,460) for the purchase of equipment for the City's Emergency Operations Center. [10/17/17 @ 1:06 PM]

- #350-17** **Bond authorization for \$1,507,105 for upgrading the financial software**
HIS HONOR THE MAYOR requesting authorization to appropriate one million five hundred seven thousand one hundred five dollars (\$1,507,105) from bonded indebtedness to upgrade the City's financial system to Tyler Technology's Munis Software. [10/30/17 @ 2:12 PM]

Items not scheduled for discussion:

#347-17 Request to transfer \$26,000 to support changes in the Comptroller's Office
HIS HONOR THE MAYOR requesting authorization to transfer the sum of twenty-six thousand dollars (\$26,000) within the Comptroller's budget from the Staffing Reserve Account to the Full-time Salaries Account to support changes in the Comptroller's Office. [10/30/17 @ 2:13 PM]

#344-17 Accept a grant from Mass DEP to be used for the recycling program
HIS HONOR THE MAYOR requesting authorization to accept and expend a grant from the Massachusetts Department of Environmental Protection as part of the Recycling Dividends Grant Program in the amount of forty-four thousand dollars (\$44,000) to support the City's recycling program. [10/17/17 @ 1:06 PM]

Referred to Programs & Services and Finance Committees

#351-17 Bond authorization for \$215,000 to purchase a bucket truck for the Forestry Division
HIS HONOR THE MAYOR requesting authorization to appropriate and expend two hundred fifteen thousand dollars (\$215,000) from bonded indebtedness for the purpose of purchasing a bucket truck for the Forestry Division of the Parks and Recreation Department. [10/30/17 @ 2:15 PM]
Programs & Services Approved 3-0-1 (Sangiolo abstaining) on 11/08/17

Referred to Programs & Services and Finance Committees

#352-17 Bond authorization for \$213,000 to renovate tennis courts at McGrath Park
HIS HONOR THE MAYOR requesting authorization to appropriate and expend two hundred thirteen thousand dollars (\$213,000) from bonded indebtedness for the purpose of renovating three tennis courts at McGrath Park. [10/30/17 @ 2:15 PM]
Programs & Services Approved 3-0-1 (Sangiolo abstaining) on 11/08/17

Referred to Programs & Services and Finance Committees

#353-17 Bond authorization for \$192,000 for two Parks & Recreation trash/recycling trucks
HIS HONOR THE MAYOR requesting authorization to appropriate and expend one hundred ninety two thousand dollars (\$192,000) from bonded indebtedness for the purpose of replacing the current Parks & Recreation trash truck with two F-550 6-cubic yard packers – one for trash and one for recycling. [10/30/17 @ 2:14 PM]
Programs & Services Approved 4-0-1 (Sangiolo abstaining) on 11/08/17

#342-17 Curb betterment abatement request
MELISSA PARENTE requesting an abatement of a curb betterment assessment in the amount of three thousand four hundred dollars (\$3,400), which improved 321 Central Street Auburndale. [10/13/17 @ 2:09 PM]

Referred to Programs & Service, Public Facilities and Finance Committees

- #178-17** **Appropriate \$500,000 for renovations to the Newton Free Library**
HIS HONOR THE MAYOR requesting authorization to appropriate the sum of five hundred thousand dollars (\$500,000) from bonded indebtedness for the purpose of funding renovations at the Newton Free Library to include expansion of the Children’s Room and other improvements to the First Floor. [05/30/17 @ 2:38 PM]
Item split into Part A and Part B. Part A – \$75,000 for design and soft costs. Part B - \$425,000 for construction costs; City Council Approved Part A on 06/19/17

Referred to Public Facilities and Finance Committees

- #171-17** **Ordinance Amendment Sec 29-80 Sewer Use Charge**
HIS HONOR THE MAYOR requesting an amendment to Section 29-80 Sewer Use Charge of the City of Newton Ordinances by adding the following sentence at the end of Paragraph (a): Notwithstanding the foregoing, seasonal water takers not eligible for an outdoor meter under said Section 29-24, shall pay a charge for the use of sewerage works in proportion to water consumption. [05/30/17@ 3:21 PM]
Public Facilities on 11/08/17

Referred to Public Facilities and Finance Committees

- #123-17** **Pilot Program for curbside food waste collection**
COUNCILORS SANGIOLO, NORTON, CROSSLEY, LENNON, AUCHINCLOSS, HARNEY, FULLER, ALBRIGHT, LAPPIN, AND LAREDO requesting the City through the Department of Public Works, pilot a curbside food waste collection program. [04/21/17 @ 11:15 AM]

Referred to Land Use and Finance Committees

- #122-17** **Discussion on fees for Special Permits**
COUNCILOR COTE requesting a discussion with the Planning & Development Department regarding the fees charged for Special Permits and what the actual costs are for issuing Special Permits. [04-18-17 @ 12:32 PM]

Referred to Public Facilities and Finance Committees

- #91-17** **Licensing agreement for wireless carriers to install equipment on city poles**
COUNCILORS CROSSLEY, ALBRIGHT AND LAPPIN requesting a discussion with the administration regarding possible licensing agreements with wireless carriers, and to create a policy and to develop and adopt a uniform license agreement for wireless carriers to install wireless communication devices on city-owned poles in the public way. [03/27/17 @ 4:44 PM]

Referred to Public Facilities and Finance Committees

- #6-17** **Request to establish filing fee for wireless attachments in the public way**
COUNCILORS CROSSLEY, ALBRIGHT, LAPPIN AND GENTILE requesting the establishment of a filing fee from petitioners seeking to attach wireless communications devices to existing or proposed structures in the public way. [12/23/2016 @ 8:37 AM]
Public Facilities Approved 6-0 and referred the item to Finance

Referred to Zoning & Planning and Finance Committees

- #444-16** **Amendment add fines for certain violations of the Accessory Apartment Ord.**
COUNCILOR BAKER AND COMMISSIONER OF INSPECTIONAL SERVICES proposing an amendment to Chapter 20 of the City of Newton Revised Ordinances to allow non-criminal ticketing of certain violations of the Accessory Apartment Ordinance. [12/16/16 @ 1:40 PM]

Referred to Land Use, Programs & Services and Finance Committees

- #256-16** **Request to extend notification area of notice for special permit petitions**
COUNCILORS COTE, NORTON, HARNEY, BLAZER, BROUSAL-GLASER, AND LEARY requesting an amendment to the City Council Rules, Article X; Section 6 – Additional Notification Requirements, to include that the area of notice for special permit petitions be expanded beyond the abutters to abutters within 300’ required by Massachusetts General Law Chapter 40A to also include property owners within 600’ of the subject property. This notification will apply to all classes of building except for residential 1 and 2-family units that will remain 1 or 2-family units after receiving a special permit. Only abutters to abutters within 300’ will be entitled to the rights conferred by Massachusetts General Law Chapter 40A. [07/01/16 @2:09 PM]
- #209-16** **Discussion of expenditures related to the Complete Streets Grant**
COUNCILOR FULLER requesting discussion regarding expenditures related to the Complete Streets grant with representatives of the Department of Public Works. [05/26/16 @ 1:11 PM]
- #112-16** **Appropriation of mitigation funds for pedestrian and traffic improvements**
HIS HONOR THE MAYOR requesting authorization to appropriate and expend the following Mitigation Funds:

A. Village Café at 719 Washington Street	\$2,500
B. 258 Nevada Street at Linwood Street	\$1,500
C. Cherry Street at Washington Street	\$2,000
D. O’Hara’s Restaurant, Newton Highlands	\$2,500
E. Rox Diner Parking & Pedestrian Improvements	\$2,500
G. Canton Circle LLC, 714-724 Beacon Street	\$10,000

- #40-16 Request to accept MGL 149 Sec 148C related to earned sick time for employees**
COUNCILOR SANGIOLO requesting that City of Newton formally accept and/or take all necessary steps to accept Massachusetts General Law Chapter 149, Section 148C, in order to qualify full-time, part-time, seasonal, and temporary employees coverage under the earned sick time regulation, 940 CMR 33, as approved by the voters of Massachusetts in the 2014 Election as Ballot Question 4 – Earned Sick Time for Employees. [01/19/16 @ 2:35 PM]

Referred to Public Facilities and Finance Committees

- #223-15 Discussion on the process of licensing the use of city buildings**
ALD. LAREDO requesting a discussion of the process of licensing the current and future use of city building, including: (a) how licensees may request the use of city buildings; (b) the process for determining which licensees will get the use of city buildings; (c) how the fees for the use of city buildings are set; and (d) how the current process compares to the process for permitting the use of school buildings. [08/13/15 @ 11:20 AM]

- #190-15 Discussion of policy to record all meetings and post meeting materials online**
ALD. SANGIOLO requesting a discussion with the Executive Department relative to creating a policy to require audio recordings of all meetings of boards and commissions and requiring them to be posted to the City's website, as well as posting of all documentation that is reviewed by boards and commissions and/or by their designated City staff member.

Referred to Zoning & Planning, Land Use and Finance Committees

- #104-15 Qualification of affordable units developed at Comm Ave, Pearl St, and Eddy St**
ALD. JOHNSON, LAREDO, AND GENTILE requesting a report from the Planning Department re how many of the affordable units developed at Commonwealth Avenue, Pearl Street, and Eddy Street qualify for inclusion on the State's Subsidized Housing Inventory List; if a property is not on the list, what can be done to make it eligible. [04/09/15 @ 12:00 PM]
Zoning & Planning voted No Action Necessary 7-0 on 04/12/17

Referred to Land Use and Finance Committees

- #49-14 Implementation of technology to monitor compliance with special permits**
LAND USE COMMITTEE requesting discussion with the Chief Financial Officer and the Chief Information Officer regarding the critical need to implement technology which enables the development, management and use of shared, searchable, mobile-accessed (both read and write) database which contains parcel-based information that can be accessed by all city departments (including Planning, Inspectional Services (ISD), Assessing, Engineering, Fire, Police, Health), the Board of Aldermen and the community. This technology must support the work of ISD and other departments in both the office

and the field to more effectively and efficiently monitor and enforce compliance with approved special permits and other related Board Orders. [02/10/14 @ 6:47 PM]

Referred to Public Safety; Prog. & Serv., Zoning & Planning; and Finance Committees

#140-14 (2) Amend ordinances to add licensing requirements and criteria for lodging houses
ZONING & PLANNING COMMITTEE requesting to amend Chapter 17, City of Newton Ordinances, to establish licensing requirements and criteria for lodging houses.

Respectfully submitted;

Leonard J. Gentile, Chair



City of Newton, Massachusetts
Office of the Mayor

SETTI D. WARREN
MAYOR

#348-17
Telephone
(617) 796-1100
Telefax
(617) 796-1113
TDD
(617) 796-1089
E-mail
swarren@newtonma.gov

October 30, 2017

Honorable City Council
Newton City Hall
1000 Commonwealth Avenue
Newton Centre, MA 02459

Ladies and Gentlemen:

I write to request that your Honorable Council docket for consideration a request to authorize the appropriation of \$7,000 from the Handicapped Parking Fine Fund to be used to pay for a special police detail enforcement of the accessible (HP) parking regulations.

For a second year in a row, at their regularly scheduled meeting on October 16, 2017 members of the Commission on Disability approved using this money for "Operation Access". "Operation Access" will take place starting with the day after Thanksgiving through the day after Christmas on weekends and some evenings targeted at malls and commercial areas. One hundred percent of the proceeds (fines) from Operation Access will go directly into the COD's HP Fines account, in order to fund projects that will directly benefit people with disabilities in Newton.

Thank you for your consideration of this matter.

Sincerely,

Setti D. Warren
Mayor

RECEIVED
Newton City Clerk
2017 OCT 30 PM 2:12
David A. Olson, CMC
Newton, MA 02459

Maureen Lemieux

Subject: FW: Request to Appropriate Funds to Renew Operation Access

From: Jini Fairley
Sent: Friday, October 20, 2017 12:17 PM
To: Setti D. Warren; Maureen Lemieux
Cc: robpcaruso; Gap4peace@aol.com; Jini Fairley; Dori F. Zaleznik
Subject: Request to Appropriate Funds to Renew Operation Access

I am sending this on behalf of the Newton COD.
Jini

Dear Mayor Warren and Maureen Lemieux,

On behalf of the Commission On Disability, we, the COD Co-Chairs, are writing to you regarding an action that took place at the COD's regularly scheduled monthly meeting on October 16, 2017.

the COD members unanimously approved \$7000 of the funds in the COD's HP Fines Account to be transferred to the Operation Access account, to be used to pay for another Operation Access enforcement, a special police detail, enforcing the accessible (HP) parking regulations during the upcoming holiday period.

Operation Access, in 2016/2017, was very successful, where 146 tickets were issued, of which 107 were issued during the holidays in 2016, and the remaining 39 tickets were issued between March and June 2017. We don't anticipate continuing Operation Access into the spring of 2018, rather annually focusing only on the holiday shopping period, the day after Thanksgiving through the day after Christmas.

The 2017 Operation Access would take place starting on November 24 through December 26, on weekends and some evenings targeted at malls and commercial areas.

One hundred percent of the proceeds (fines) from Operation Access will go directly into the COD's HP Fines account, in order to fund projects that will directly benefit people with disabilities in Newton. The Police Department have assured me that they will record the ticket number of the violators, as well as the Officer's name, and date and time of his/her shift during their Operation Access assignment, in order to properly track the collected fines of which 100% will be credited to the COD's HP Fines Account.

We hope you will support the COD's decision to renew Operation Access for this upcoming 2017 holiday period. We would appreciate the docketing of this item for the City Council to appropriate these funds at their next scheduled meeting, in order for Operation Access to begin in late November.

Thank you for your consideration of this request to appropriate funds in the amount of \$7,000 from the COD's HP Fines Account in order to renew Operation Access.

Sincerely,

**Rob Caruso, Co-Chair
Girard Plante, Co-Chair**

#354-17



SETTI D. WARREN
MAYOR

City of Newton, Massachusetts
Office of the Mayor

Telephone
(617) 796-1100

Telefax
(617) 796-1113

TDD
(617) 796-1089

E-mail
swarren@newtonma.gov

October 30, 2017

Honorable City Council
Newton City Hall
1000 Commonwealth Avenue
Newton Centre, MA 02459

Ladies and Gentlemen:

I write to request that your Honorable Council docket for consideration a request to authorize the appropriation of the sum of \$106,000 and authorize a general obligation borrowing of an equal amount to upgrade the Toughbooks in the City's olice Department first line response vehicles.

Thank you for your consideration of this matter.

Sincerely,

A handwritten signature in cursive script that reads "Setti D. Warren".

Setti D. Warren
Mayor

RECEIVED
Newton City Clerk
2017 OCT 30 PM 2:14
David A. Olson, CMC
Newton, MA 02459



Steven R. Smith
Bureau Commander

NEWTON POLICE DEPARTMENT INFORMATION SYSTEMS

1321 Washington Street
Newton, MA 02465
v (617) 796-2105
f (617) 796-3683

354-17

November 5, 2017

Cruiser Computer Replacements (\$120,000) 36 Units

Justification Regarding Importance

The Police Department relies heavily on computer system in the Officers' cruiser. These systems provide Registry of Motor Vehicle information, access to our dispatch and reporting systems, Global Positioning of Cruisers, Building Floor Plans, Self Initiated Directed Patrols, Missing Person Pictures, Accident Reporting and internal information systems. The current computers have exceeded their life expectancy, having been in service 24x7 for four years. Many are now defunct or not working properly.

Service to Residents

The ability to operate effectively and effectively throughout the City provides increased productivity by not having the Officer return to the station to complete a written report or accident information. Additionally these computers provide GPS information, missing person pictures, and critical internal information.

Ramification of Delaying

Delaying this purchase reduces the operational efficiency for the Officers, increases Officer Safety issues, as they cannot run plates and verify identification, increases the work then required by dispatchers to provide Officers information, and will require Officers to return to the station to complete reports. At this time we are required to re-image all of the working cruisers computers to meet an upgrade of our records management system, and delaying this purchase will require the department to duplicate its efforts at a later date

Additional Benefits

Several of the current cruiser laptops will be repurposed to provide the Command Staff with direct remote access from home to their respective desktops.



NEWTON POLICE DEPARTMENT INFORMATION SYSTEMS

1321 Washington Street
Newton, MA 02465
v (617) 796-2105
f (617) 796-3683

Steven R. Smith
Bureau Commander

What are we purchasing

- The cruisers are currently equipped with laptop computers that are over four years old. They are utilized 24 hours a day and are in need of replacement.
- We are requesting funds for a hardware purchase. This is to replace the current laptop computers that are in the cruisers.

Why a particular vendor

- The laptop computers are fitted into a custom stand in the cruisers. We intend to reuse those hardware stands.

Why buy all now

- We would like to maintain the current Windows 7 platform. Soon that will not be a purchase option and we will be forced to Windows 10.
- Computers are imaged in maximize deployment and uptime. Maintaining hardware consistency insures interchanging of hardware.

NEWTON POLICE DEPARTMENT

MANIFOLD
 TRAINING OPPORTUNITIES
 All Hazards Plan
 FLEET STATUS
 VEHICLE INSPECTIONS
 POLICE PICTURES
 GENERAL ORDERS
 STREET DIRECTORY
 DIRECTED PATROLS
 ITEMS OF INTEREST
 BUILDING FLOOR PLANS
 DETAILS POLICY
 DETAILS SIGN UP INFO
 CENSUS
 DOG LICENSE BY OWNER
 DOG LICENSE BY LIC #

These are some of the in vehicle functions that are provided through use of the lap top computers, in addition to Report Generation, GPS, RMV, and Directed Patrols.



NEWTON POLICE DEPARTMENT
INFORMATION SYSTEMS

1321 Washington Street
Newton, MA 02465
v (617) 796-2105
f (617) 796-3683

Steven R. Smith
Bureau Commander

Brite

7647 Main Street Fishers Victor NY 14564
Telephone: (585) 758-0200
FAX: (585) 758-0222
Toll Free: (800)-333-0498
salesinfo@britecomputers.com
NYS OGS: Fujitsu America, Inc. - PM21110

Quote

Page 1 of 2

Date of Quote

12/23/2016

Quote #

Q69713

Bill To	Ship To
NEWTON POLICE DEPARTMENT 1321 WASHINGTON ST NEWTON MA 2465	NEWTON POLICE DEPARTMENT 1321 WASHINGTON ST NEWTON MA 2465

Quote Expirati...	Terms	PO #	Sales Rep	Shipping Via	FOS
3/31/2017	NET 30		James M Foos		Brke Whse

Part Number	Description	Qty	Unit Price	Extended
FUJ-BQJAD30000PAABBN	STYLISTIC Q736,CORE i5-6200U,8GB,13.3FHD AG,TOUCH&PEN,128GB SSD,NO WWAN,INTEL(AGN)WLAN,BT,NO NFC,CAM,TPM(2.0),STSHLL,FP,19V/65W(3-Pin),WIN10PRO(64-BIT),3YR,ES,WIN10PRO(64-BIT)REC	36	1,463.00	52,668.00
FUJ-FUJ38-1633-01	Covers accidental damage for a period of three years from the date of unit purchase. Covers up to one qualified incident per year whether major or minor part. If unit needs to be sent out for repair, Fujitsu pays for the return shipment to the customer. If unit is beyond repair, Fujitsu offers one replacement within the warranty period. Once a unit is replaced, the remaining ADP warranty contract will be exhausted. The Standard International Limited Warranty is also included in this program.	36	158.00	5,688.00
FUJ-FPCC0184AP	Fujitsu Protective TPU Cover w/ Handstrap (Q736 or Q775)	36	98.00	3,528.00
	Vehicle Dock, Power adapter and Hand strap Dock to be used on existing swing away mounts.			
BR-FUJQ-DOCK	Q-Series Active Dock for swing away mount and complete electronics - 3yr	36	705.00	25,380.00
LUN-LI-FUJ-Q775/Q736DCSA-3	Fujitsu Q775/Q736 Active Dock for Swing Away Mount- 3 Yr Warranty	36	0.00	0.00
LIN-CBLOP-F02736	LIND 6' RT Angle Cable for Q775/Q736 Active Dock- cable only	36	0.00	0.00
ELE-509559	Elegant X-Handle for Q736 TPU Case	36	0.00	0.00
	Replacement keyboard and keyboard tray			



**NEWTON POLICE DEPARTMENT
INFORMATION SYSTEMS**

1321 Washington Street
Newton, MA 02465
v (617) 796-2105
f (617) 796-3683

Steven R. Smith
Bureau Commander

Brite

7647 Main Street Fishers Victor NY 14564
Telephone: (585) 758-0200
FAX: (585) 758-0222
Toll Free: (800)-333-0498
salesinfo@britecomputers.com

Quote

Page 2 of 2

Date of Quote:

12/23/2016

Quote #:

Q69713

Part Number	Description	Qty	Unit Price	Extended
LUN-IKEY-THN	Keyboard Tray for I-Key Thin SB-87-TP with glide point - needs TS-60 or TS-1	36	84.00	3,024.00
IKE-FT-88-911-TP	iKey Backlit Keyboard with Integrated Touchpad	36	250.00	9,000.00
	Accessories- Included at no cost assuming quantities of 36 are purchased			
FUJ-FPCKE432AP	Power Keyboard Docking Station	1	0.00	0.00
FUJ-FPCPR294AQ	Performance Docking Cradle	1	0.00	0.00

Total \$99,288.00

*Building Relationships,
Strengthening Partnerships,
Providing Solutions

For Technical Support call (800) 333-0498 (option 1)





SETTI D. WARREN
MAYOR

City of Newton, Massachusetts
Office of the Mayor

#320-17

Telephone
(617) 796-1100

Telefax
(617) 796-1113

TDD
(617) 796-1089

E-mail
swarren@newtonma.gov

October 12, 2017

Honorable City Council
Newton City Hall
1000 Commonwealth Avenue
Newton Centre, MA 02459

Ladies and Gentlemen:

In response to Docket Item #320-17, I write to request that your Honorable Council transfer the sum of \$97,000 from Acct # 0110498-5790 Current Year Reserve to fund the construction of fencing and vegetation to act as a "screen" around areas of the Rumford Avenue Solar Site.

Thank you for your consideration of this matter.

Sincerely,

A handwritten signature in cursive script that reads "Setti D. Warren".

Setti D. Warren
Mayor

Fence Quotes from Ameresco, 6-9-2017

Quotes do not include ivy, irrigation or maintenance.

As promised here is the breakdown for the 3 fence options:

Opt #1 – 2.5' black vinyl fence extension

1. Fence material and labor	\$10,626
2. Ballast Block material	\$11,954
3. Placement of Block	\$ 6,450
4. AMEC Engr. & Supervision	\$10,000
5. <u>Ameresco Mngt.</u>	<u>\$ 5,355</u>
Total	\$44,885

Opt #2 – 7' Agricultural fence

1. Fence material and labor	\$17,550
2. Ballast Block material	\$46,010
3. Placement of Block	\$13,375
4. AMEC Engr. & Supervision	\$10,000
5. <u>Ameresco Mngt.</u>	<u>\$13,041</u>
Total	\$99,976

Opt #3 – 9.5' Agricultural fence

1. Fence material and labor	\$21,000
2. Ballast Block material	\$71,690
3. Placement of Block	\$13,375
4. AMEC Engr. & Supervision	\$10,000
5. <u>Ameresco Mngt.</u>	<u>\$17,410</u>
Total	\$133,475



City of Newton Attn: Bill Ferguson

May 8, 2017
Rumford Avenue Fence at Solar Panel Site

wferguson@newtonma.gov

We Propose hereby to furnish material and labor-complete in accordance with specifications below, for the sum of:
Twenty-Eight Thousand Seven Hundred and Fifty Dollars **\$28,750.00**

Per billing

All material is guaranteed to be as specified. All work to be completed in a workmanlike manner according to standard practices. Any alteration or deviation from specifications below involving extra costs will be executed only upon written orders, and will become an extra charge over and above the estimate. All agreements contingent upon strikes, accidents or delays beyond our control. Owner to carry fire, tornado and other necessary insurance. Our workers are fully covered by Workman's Compensation Insurance.

Authorized
Signature

Note: This proposal may be
Withdrawn by us if not accepted within _____ days.

We hereby submit specifications and estimates for:

Provide and install 800 Baltic Ivy 1 Gal. pots with 12in. stake along fence 800 ft. long spacing 12in on center. Price includes removal of any grass.

Install loam/compost mixture to amend soil to create a health growing environment. Install bark mulch to entire area. Recommend planting bed to be 30in-36in. wide to protect Ivy.

Total **\$28,750.00**

Acceptance of Proposal – The above prices, specifications and conditions are satisfactory and are hereby accepted. You are authorized to do the work as specified. Payment will be made as outlined above.
Date of Acceptance: _____

Signature _____

Signature _____

4/26/17 - revised
4-4-17

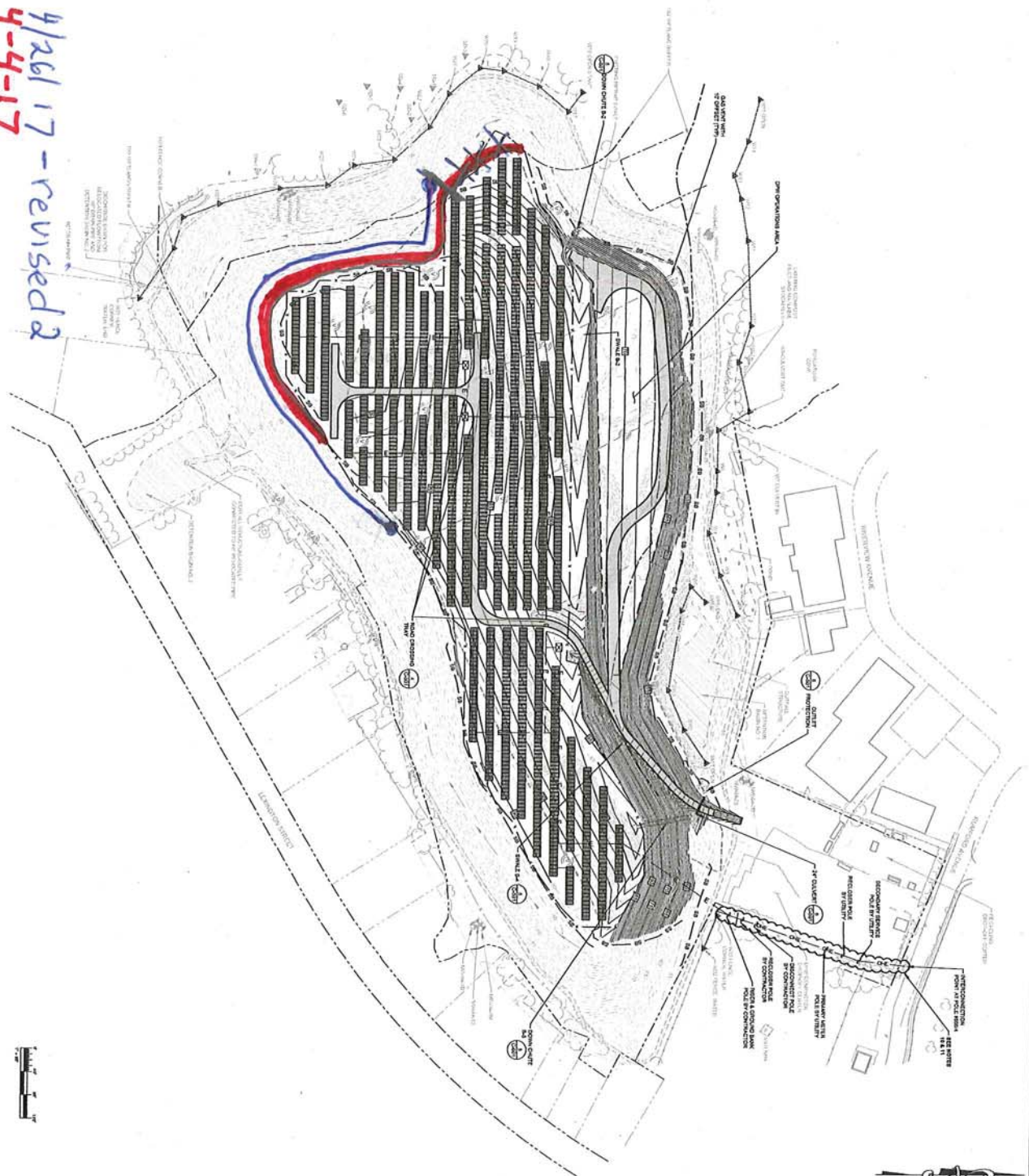

GENERAL NOTES:

1. THE DESIGN OF THE SITE IS TO BE USED AS A GUIDE IN THE CONSTRUCTION OF THE SITE. THE DESIGNER SHALL BE RESPONSIBLE FOR THE DESIGN AND CONSTRUCTION OF THE SITE.
2. THE DESIGNER SHALL BE RESPONSIBLE FOR THE DESIGN AND CONSTRUCTION OF THE SITE.
3. THE DESIGNER SHALL BE RESPONSIBLE FOR THE DESIGN AND CONSTRUCTION OF THE SITE.
4. THE DESIGNER SHALL BE RESPONSIBLE FOR THE DESIGN AND CONSTRUCTION OF THE SITE.
5. THE DESIGNER SHALL BE RESPONSIBLE FOR THE DESIGN AND CONSTRUCTION OF THE SITE.
6. THE DESIGNER SHALL BE RESPONSIBLE FOR THE DESIGN AND CONSTRUCTION OF THE SITE.
7. THE DESIGNER SHALL BE RESPONSIBLE FOR THE DESIGN AND CONSTRUCTION OF THE SITE.
8. THE DESIGNER SHALL BE RESPONSIBLE FOR THE DESIGN AND CONSTRUCTION OF THE SITE.
9. THE DESIGNER SHALL BE RESPONSIBLE FOR THE DESIGN AND CONSTRUCTION OF THE SITE.
10. THE DESIGNER SHALL BE RESPONSIBLE FOR THE DESIGN AND CONSTRUCTION OF THE SITE.
11. THE DESIGNER SHALL BE RESPONSIBLE FOR THE DESIGN AND CONSTRUCTION OF THE SITE.
12. THE DESIGNER SHALL BE RESPONSIBLE FOR THE DESIGN AND CONSTRUCTION OF THE SITE.

PLAN REFERENCES:

1. THE DESIGNER SHALL BE RESPONSIBLE FOR THE DESIGN AND CONSTRUCTION OF THE SITE.
2. THE DESIGNER SHALL BE RESPONSIBLE FOR THE DESIGN AND CONSTRUCTION OF THE SITE.
3. THE DESIGNER SHALL BE RESPONSIBLE FOR THE DESIGN AND CONSTRUCTION OF THE SITE.
4. THE DESIGNER SHALL BE RESPONSIBLE FOR THE DESIGN AND CONSTRUCTION OF THE SITE.
5. THE DESIGNER SHALL BE RESPONSIBLE FOR THE DESIGN AND CONSTRUCTION OF THE SITE.
6. THE DESIGNER SHALL BE RESPONSIBLE FOR THE DESIGN AND CONSTRUCTION OF THE SITE.
7. THE DESIGNER SHALL BE RESPONSIBLE FOR THE DESIGN AND CONSTRUCTION OF THE SITE.
8. THE DESIGNER SHALL BE RESPONSIBLE FOR THE DESIGN AND CONSTRUCTION OF THE SITE.
9. THE DESIGNER SHALL BE RESPONSIBLE FOR THE DESIGN AND CONSTRUCTION OF THE SITE.
10. THE DESIGNER SHALL BE RESPONSIBLE FOR THE DESIGN AND CONSTRUCTION OF THE SITE.
11. THE DESIGNER SHALL BE RESPONSIBLE FOR THE DESIGN AND CONSTRUCTION OF THE SITE.
12. THE DESIGNER SHALL BE RESPONSIBLE FOR THE DESIGN AND CONSTRUCTION OF THE SITE.

LEGEND:

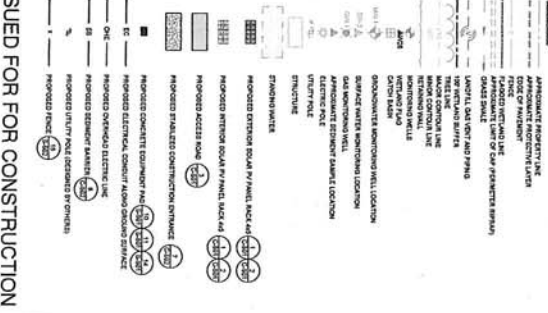

ISSUED FOR FOR CONSTRUCTION

			<p>MECHANICAL CONSULTING ENGINEERS</p>		
<p>RUMFORD AVENUE SOLAR LLC 111 SPEEN STREET FRAMMINGHAM, MA 01701</p>			<p>PROJECT: NEWTON LANDFILL 2.17 MW SOLAR PV DEVELOPMENT NEWTON, MASSACHUSETTS</p>		
<p>DRAFT</p>			<p>PROPOSED SITE PLAN</p>		
<p></p>			<p>DATE: 4/26/17</p>		
<p>3 OF 8</p>			<p>APPROVED BY: [Signature]</p>		



City of Newton Attn: Bill Ferguson

May 9, 2017
Irrigation Installation at Rumford Avenue

wferguson@newtonma.gov

We Propose hereby to furnish material and labor-complete in accordance with specifications below, for the sum of:
Two Thousand Four Hundred Thirty-Seven Dollars and 25 Cents **\$2,437.25**

Per billing

All material is guaranteed to be as specified. All work to be completed in a workmanlike manner according to standard practices. Any alteration or deviation from specifications below involving extra costs will be executed only upon written orders, and will become an extra charge over and above the estimate. All agreements contingent upon strikes, accidents or delays beyond our control. Owner to carry fire, tornado and other necessary insurance. Our workers are fully covered by Workman's Compensation Insurance.

Authorized
Signature

Note: This proposal may be
Withdrawn by us if not accepted within _____ days.

We hereby submit specifications and estimates for:

Installation of drip irrigation to new plantings along fence consisting of:

- (1) zone battery Hunter Node.
- (1) Hunter mini-click sensor.
- (1) Hunter 1" zone valve.
- 2400' Tech line drip pipe

Sub Total	\$2,340.94
Mass Sales Tax	\$96.31
Total	\$2,437.25

*Plumbing and electrical not included.

Acceptance of Proposal – The above prices, specifications and conditions are satisfactory and are hereby accepted. You are authorized to do the work as specified. Payment will be made as outlined above.
Date of Acceptance: _____

Signature _____
Signature _____

Fence	\$ 44,885.00
Ivy	\$ 28,750.00
Irrigation	\$ 2,437.25
Trees	\$ 20,928.00
Total	\$ 97,000.00



SETTI D. WARREN
MAYOR

City of Newton, Massachusetts
Office of the Mayor

#343-17
Telephone
(617) 796-1100
Facsimile
(617) 796-1113
TDD/TTY
(617) 796-1089

E-mail
swar@newtonma.gov

RECEIVED
Newton City Clerk
2017 OCT 20 AM 9:46
David A. Olson, CMC
Newton, MA 02459

October 20, 2017

Honorable City Council
Newton City Hall
1000 Commonwealth Avenue
Newton, MA 02459

Ladies and Gentlemen:

I write to request that your Honorable Council docket for consideration a request to accept a grant for \$3500 from Mass Housing for Hoarding Services to support the work of the Newton Hoarding Task Force. Please see the accompanying letter from Health & Human Services Commissioner Deborah Youngblood for a further explanation.

Thank you for your consideration of this matter.

Very truly yours,

Setti D. Warren
Mayor

1000 Commonwealth Avenue Newton, Massachusetts 02459

www.newtonma.gov



DEDICATED TO COMMUNITY EXCELLENCE

City of Newton



Setti D. Warren
Mayor

HEALTH AND HUMAN SERVICES DEPARTMENT

Deborah C. Youngblood, PhD, Commissioner

1000 Commonwealth Avenue
Newton, MA 02459

Telephone 617.796.1420 Fax 617.552.7063
TDD/TTY 617.796.1089



Public Health
Prevent. Promote. Protect.

October 17, 2017

To: Mayor Setti Warren

From: Deborah Youngblood, Commissioner of HHS

Re: Award of \$3500 grant from Mass Housing for hoarding services

Dear Mayor Warren,

The City of Newton has been awarded a \$3,500 grant to support the activities of our Newton Hoarding Task Force and better serve residents who are suffering from this challenging disorder. The grant money will be utilized for the following:

- 1) Community education to promote prevention and early intervention,
- 2) Expansion and enhancement of a mental health/academic partnership to provide college student interns to residents to support in home sorting and discarding,
- 3) Develop and implement a funding model to support home organization and clean up services when financially necessary and clinically appropriate.

We respectfully request that we are allowed to accept these funds and are able to enhance our work in this area.

Sincerely,

Deborah C. Youngblood



City of Newton, Massachusetts
Office of the Mayor

SETTI D. WARREN
MAYOR

#346-17
Telephone
(617) 796-1100
Telefax
(617) 796-1113
TDD
(617) 796-1089
E-mail
swarren@newtonma.gov

October 30, 2017

Honorable City Council
Newton City Hall
1000 Commonwealth Avenue
Newton Centre, MA 02459

RECEIVED
Newton City Clerk
2017 OCT 30 PM 2:17
David A. Olson, CMC
Newton, MA 02459

Ladies and Gentlemen:

I write to request that your Honorable Council docket for consideration a request to authorize the transfer of necessary funding from Acct # 0110498-5197 Current Year Wage Reserve to the accounts submitted to the City Council as part of this docket item for the FY18 one-year settlement of the Collective Bargaining Agreement covering AFSCME Local 3092 employees. This agreement has settled in accordance with the City's practice of maintaining parity between the rate of growth of expenditures and revenues.

Thank you for your consideration of this matter.

Sincerely,

Setti D. Warren
Mayor



City of Newton, Massachusetts
Office of the Mayor

SETTI D. WARREN
MAYOR

#349-17
Telephone
(617) 796-1100
Telefax
(617) 796-1113
TDD
(617) 796-1089
E-mail
swarren@newtonma.gov

October 30, 2017

Honorable City Council
Newton City Hall
1000 Commonwealth Avenue
Newton Centre, MA 02459

Ladies and Gentlemen:

I write to request that your Honorable Council docket for consideration a request to authorize the appropriation and expenditure of \$41,080 from the City's Inclusionary Zoning Fund and an equal amount from the Newton Housing Authority's ~~Inclusionary Zoning Fund~~ for the purpose of repaying HOME funds in the amount of \$82,160.

*OK
mll 11/1/17*

Please see the detailed request from the Planning Department. Staff members will be happy to discuss this matter with members of the appropriate committees.

Thank you for your consideration of this matter.

Sincerely,

Setti D. Warren
Mayor

RECEIVED
Newton City Clerk
2017 OCT 30 PM 2:15
David A. Olson, CMC
Newton, MA 02459



Setti D. Warren
Mayor

City of Newton, Massachusetts
Department of Planning and Development
1000 Commonwealth Avenue Newton, Massachusetts 02459

Telephone
(617) 796-1120
Telefax
(617) 796-1142
TDD/TTY
(617) 796-1089
www.newtonma.gov

Barney S. Heath
Director

MEMORANDUM

October 19, 2017

TO: Maureen Lemieux, Chief of Staff/Chief Financial Officer
Dori Zaleznik, Chief Administrative Officer
FROM: Barney Heath, Director of Planning & Development

SUBJECT: Request for Inclusionary Zoning Funds to Facilitate Rehabilitation of 83-85 West Street

The City of Newton's First Time Homebuyer Program, through the Newton Community Development Authority (NCDA), assisted the above-mentioned property in June 2004 with down payment assistance in the amount of \$90,000, utilizing HOME funds. It became apparent, however, during fall 2016 that the property was in distress. Holding a Declaration of Affordable Housing Covenants ("Declaration") on the property, the NCDA possessed the right of first refusal. Facing foreclosure and likely loss of an affordable homeownership unit, the City partnered with the Newton Housing Authority to avoid foreclosure and preserve the property's affordability. Consequently, the NCDA, through the provision in the Declaration, elected to assign its first right of refusal to the Newton Housing Authority. Working within strict time constraints, the Housing Authority purchased the property and has subsequently requested CDBG funds to assist with the property's refinance and rehabilitation in creating two, permanently deed-restricted rental units in perpetuity.

However, since the property will no longer meet the requirements of the Declaration and Mortgage as ownership housing, the property is out of compliance requiring the HOME funds to be repaid. The repayment of HOME funds in the amount of \$82,160 was calculated per the guidelines outlined in the Declaration. HUD has indicated that before any additional CDBG/HOME can be expended on the property, the HOME repayment amount must to be paid back (to the City) from a non-federal source.

Because we are partnering with the Newton Housing Authority on the project, we are requesting to utilize \$41,080 (50% of the lien) from the City's Inclusionary Housing Fund (3314Q2). The Newton Housing Authority would provide the City with a check for the other 50% of the lien (\$41,080).

Both checks would recaptured as HOME Program Income and can be allocated for the development of affordable housing; in this instance the program income will go toward the Auburn Street project.

Please let me know if you should have any questions relative to this request.



SETTI D. WARREN
MAYOR

City of Newton, Massachusetts
Office of the Mayor

#356-17
Telephone
(617) 796-1100
Telefax
(617) 796-1113
TDD
(617) 796-1089
E-mail
swarren@newtonma.gov

October 30, 2017

Honorable City Council
Newton City Hall
1000 Commonwealth Avenue
Newton Centre, MA 02459

Ladies and Gentlemen:

I write to request that your Honorable Council docket for consideration a request to authorize the appropriation of the sum of \$280,000 and authorize a general obligation borrowing of an equal amount to purchase a Gradall for Public Works. This item is included in the FY19-FY23 Capital Improvement Plan.

Thank you for your consideration of this matter.

Sincerely,

Setti D. Warren
Mayor

RECEIVED
Newton City Clerk
2017 OCT 30 PH 2:16
David A. Olson, CMC
Newton, MA 02459

City of Newton



Setti D. Warren
Mayor

DEPARTMENT OF PUBLIC WORKS

OFFICE OF THE COMMISSIONER

1000 Commonwealth Avenue
Newton Centre, MA 02459-1449

October 30, 2017

To: Mayor Setti Warren
Maureen Lemieux, CFO

I write to request that the Honorable Council docket for consideration a request to authorize the appropriation of \$280,000 and authorize a general obligation borrowing of an equal amount to fund the purchase of a new Gradall XL4100 Vehicle for the Public Works Department to replace an outdated.2000 Gradall.

Thank you for your consideration of this matter.

Sincerely,

Jim McGonagle
Commissioner of Public Works

Jim McGonagle
Commissioner

MUNICIPAL AND CONTRACTORS' EQUIPMENT

200 Merrimac St
Woburn MA 01801

PROPOSAL

Tel. (781) 935 1919
Fax. (781) 937 9809

To:

City of Newton
Department of Public Works
110 Crafts St
Newton, MA 02460

November 2, 2017

ATT: Ron Mahan Fleet Supervisor

C. N. Wood is pleased to offer the following proposal through the NJPA national contract for your consideration.

1 New 2017 GRADALL XL3300V all-wheel drive hydraulic excavator with Volvo tier 4F 4 cylinder liquid cooled 172 gross HP engine, rated bucket breakout force 19,300 lb., rated boom force 22,075 lb, travel speed 20mph, dozer blade, 24, volt electrical system, fuel tank capacity 99 gal, urea tank capacity 10.5 gal, front and rear axle model ZF 3070, LED work light package, 8 LED flashers on all corners, LED beacon light with limb guard, air conditioner, am/fm stereo radio, printed set of parts, service and operators manuals, GVW 41,000 1 year standard warranty and all other standard equipment.

ADDITIONAL STANDARD EQUIPMENT

Mechanical Coupler

Auxiliary Hydraulics with Auxiliary Hydraulic Plumbing

36" Excavating bucket

60" Ditching bucket

TOTAL SELLING PRICE \$308,995.00

C. N. Wood Co, Inc. is looking forward to providing the City of Newton with the GRADALL premium products and first class service. Please do not hesitate to contact me if you have any questions or need further information.

Thank you for considering C. N. Wood for your equipment needs.

Best Regards,

Stephen M. Russell

Sales Representative

No warranties are made other than those extended by the manufacturer of the equipment, and in the event of alleged breach of warranty, expressed or implied, the liability of C. N. Wood Co., Inc., shall be limited to the liability of the manufacturer to it, and shall be subject to all limitations and conditions imposed by the manufacturer.

Seller shall not be liable for any default or delay in delivery, as a result of shipping delays, strikes, fires, lockouts, or inability to procure materials.

GRADALL®**XL 3300 V**

HYDRAULIC EXCAVATOR



SPECIFICATIONS

Upperstructure Engine

VOLVO TAD571 VE, TIER 4f, 4 cycle, inline 4 cylinder, liquid cooled, electronic controlled. Vertical canister style lube filter attached to engine. Vertical canister style main fuel filter and fuel/water separation with manual feed pump attached to engine. Water in fuel indicator and alarm.

Gross Rating: 172 HP @ 2000 RPM (128kW)
590 ft lb Torque @ 1100-1500 RPM (800Nm)

Net Rating: 152 HP @ 2000 RPM (113kW)

Variable viscous fan clutch system. Vertical stacked hydraulic oil cooler, charge air cooler and radiator.

Maximum slope: 30°

24 volt starter, 100 amp alternator, two SAE #C31-S 1000 CCA batteries, two-stage air cleaner with high-efficiency pre-cleaner, vacuator valve and remote service indicator.

Fuel tank capacity: 99 gallons (375 L).

Hydraulic System**PUMPS**

One load-sensing, axial piston pump; oil flow 0-100 GPM (0-378 L/min).

Tandem gear pump (steering, brake/pilot) 10 GPM (38 L/min), 6 GPM (23 L/min)

SYSTEM MONITOR

Electronic monitor in cab indicates low hydraulic fluid level, high hydraulic fluid temperature, system working pressure, system pilot pressure.

SYSTEM SPECIFICATIONS**Six Cylinders**

- 1 tool: 4.25" ID, 3.0" rod (108 mm x 76 mm), 25.9" (658 mm) stroke.
- 2 hoist: 3.50" ID, 2.559" rod (89 mm x 65 mm), 31.0" (787 mm) stroke.
- 1 telescope: 3.5" ID, 2.559" rod (89 mm x 65 mm), 11' (3.35 m) stroke.
- 2 single-acting axle oscillation cylinders: 4.528" ID, 4.528" rod (115 mm x 115 mm), 6.25" (159 mm) stroke.

Three Hydraulic Motors

Swing, 51 hp (38 kW); tilt, 21 hp (16 kW); propel motor, 113 hp (84 kW).

Operating Pressures:

Hoist.....	4,900 psi	(331 BAR)
Tilt.....	2,500 psi	(172 BAR)
Swing.....	3,000 psi	(207 BAR)
Tool.....	4,900 psi	(331 BAR)
Telescope.....	4,900 psi	(331 BAR)
Propel.....	4,900 psi	(331 BAR)
Pilot System.....	550 psi	(38 BAR)
Braking & Steering.....	2,400 psi	(165 BAR)
Blade & Stabilizers.....	4,000 psi	(207 BAR)

Oil Capacity

Reservoir system 65 gallons (246 L).
Pressurized reservoir with visual oil level gauges.

Filtration System

10 micron return filter, 10 micron pilot filter.

Fin and tube-type oil cooler with thermal by-pass and relief valves.

Pressure-compensated, load-sensing valves with circuit reliefs in all circuits.

Operator Cab

All-weather cab with tinted safety glass windows, skylight, acoustical lining, four-way adjustable operator's seat, AM/FM radio, filtered fresh air heater, defroster and A/C. Front window slides to overhead storage. Rearview mirrors on right and left sides. Standard equipment includes operator's seat belt, windshield wiper and washer, high/low beam headlights, parking lights, brake lights, 4-way hazard lights, turn indicator lights, work lights and swing lights.

Controls

Two electronic joysticks (hoist and bucket, telescope and swing), one rocker switch (tilt) control upperstructure. Joysticks mounted on arm pods, independently adjustable for individual operator comfort and convenience. Quick change joystick pattern switch located on instrument panel. Joysticks are self-centering; when controls are released, power for movement disengages and swing and tilt brake set automatically.

A tilting/telescoping steering column provides smooth, comfortable steering. Hydraulic foot pedal controls braking functions, giving smooth performance with infinite control. Travel speed is regulated with an electronic foot pedal control. A switch on the FWD/REV selector provides 1st/2nd gear selection. Independent rocker switches control stabilizers, axle oscillation, park brake and hazard lights. Another switch on the column provides marker lights, high/low headlights and direction indicators.

Engine Controls and Instrumentation

Key operated ignition/starter switch, throttle and main battery disconnect switch. Air cleaner condition indicator. Electronic monitor indicates fuel level, low battery charge, lube oil pressure, high coolant temperature, engine rpm and engine hours. Fuel saving auto idle feature sends engine rpm to idle when control circuits are in neutral for seven seconds.

Swing

Priority swing circuit with axial piston motor. Planetary transmission.

Swing speed: 8.0 RPM.

Swing Brake

Automatic spring-set/hydraulic release wet-disc parking brake. Dynamic braking is provided by the hydraulic system.

Undercarriage

A full-time 4-wheel drive transfer case delivers power from the hydraulic drive motor to the drive axles. Both axles are equipped with internal wet-disc type service brakes. The steering axle is fitted with oscillation lock cylinders. Optional stabilizer arms provide a solid digging platform for increased stability. A blade attachment for finish grading (as shown) is one of many options available for specific applications.

Tires: 10.00 x 20 Super-Lug.

Axles: ZF Model 3070 (FTF 2090).

Transmission: ZF Model HL 290.

Drive Motor: Rexroth A6 Series, 160cc/Rev.

Minimum Turning Radius: 25'1" (7.65 m).

Undercarriage Drive

Variable displacement high torque piston motor powers the 2-speed power shift transmission. Speed mode selection can also be done while moving. Electronically operated travel alarm signals excavator movement.

Travel speed on flat, level surface--mph (km/hr):

	Creep Mode	Standard Mode
First Gear	1.8 mph (2.9 kmh)	5.7 mph (9.2 kmh)
Second Gear	6.3 mph (10.1 kmh)	20.0 mph (32.2 kmh)

Weight

Approximate working weight with 36" (914 mm) excavating bucket, fuel tank half full.

39,294 lb (17,823 kg)

Outriggers = 2,720 lb (1,234 kg)

Blade = 1,480 lb (671 kg)

Rated Bucket Breakout Force:

19,300 lb (86 kN).

Rated Boom Force: 22,075 lb (98.2 kN).

GRADALL Model XL 3300 V Excavator Rated Lift Capacity - LB (KG)

LOAD POINT HEIGHT		LOAD RADIUS								
		10' 0" (3.0 m)		15' 0" (4.6 m)		20' 0" (6.1 m)		Maximum Radius		
		Over End	Over Side	Over End	Over Side	Over End	Over Side		Over End	Over Side
Above Ground Level	15' 0" (4.6 m)			6630 (3350)	6630 (3350)	4455 (2020)	4455 (2020)	22' 7" (6.9 m)	3690 (1675)	3690 (1675)
	10' 0" (3.0 m)			7870 (3570)	7870 (3570)	5050 (2290)	5050 (2290)	24' 0" (7.3 m)	3705 (1680)	3705 (1680)
	BOOM LEVEL 8' 6" (2.6 m)			8095 (3670)	8095 (3670)	5160 (2340)	5160 (2340)	24' 2" (7.4 m)	3725 (1690)	3725 (1690)
	5' 0" (1.5 m)			8150 (3695)	8150 (3695)	5245 (2380)	5245 (2380)	24' 2" (7.4 m)	3775 (1710)	3775 (1710)
At Ground Level				7140 (3240)	7140 (3240)	4920 (2230)	4920 (2230)	23' 4" (7.1 m)	3875 (1760)	3875 (1760)
Below Ground Level	15' 0" (4.6 m)	6285 (2850)	6285 (2850)	5565 (2525)	5565 (2525)	4230 (1920)	4230 (1920)	21' 2" (6.4 m)	3950 (1790)	3950 (1790)
	10' 0" (3.0 m)	3855 (1750)	3855 (1750)	4095 (1855)	4095 (1855)			17' 1" (5.2 m)	3850 (1745)	3850 (1745)

NOTE: The above loads are in compliance with the SAE standard J1097 DEC2005. They do not exceed 87% of hydraulic lifting capacity or 75% of tipping capacity.

The rated lift capacity is based on the machine being equipped with 6,000 lb (2724 kg) counterweight, standard boom, standard tires, no auxiliary hydraulics and no bucket.

Adjust the listed rated capacities by subtracting the value listed for bucket/attachment used:

8065-6007 60" (1.5 m)	Ditching -	807 lbs (366 kg)
8065-6006 66" (1.7 m)	Ditching -	892 lbs (405 kg)
8065-6118 72" (1.6 m)	Ditching -	1148 lbs (521 kg)
8045-6020 24" (610 mm)	Excavating -	603 lbs (274 kg)
8045-6020 30" (762 mm)	Excavating -	660 lbs (300 kg)
8045-6022 36" (914 mm)	Excavating -	741 lbs (336 kg)
8045-6023 42" (1.1 m)	Excavating -	841 lbs (382 kg)
8065-6117 48" (1.5 m)	Excavating -	959 lbs (435 kg)
8065-6013 72" (1.8 m)	Dredging -	1114 lbs (505 kg)
8065-6102 40" (1.0 m)	Pavement -	1262 lbs (573 kg)
8065-6024 8" (2.4 m)	Blade -	630 lbs (285 kg)
8065-6009 Single Tooth	Ripper -	557 lbs (253 kg)

NOTE: Bucket adjustment values are 87% of the actual bucket weights.

The load point is located on the bucket pivot point, including loads listed for maximum radius.

Do not attempt to lift or hold any load greater than these rated values at specified load radii and heights. The weight of slings and any auxiliary devices must be deducted from the rated load to determine the net load that may be lifted.

ATTENTION: All rated loads are based on the machine being stationary and level on a firm supporting surface. The user must make allowance for particular job conditions such as soft or uneven ground, out of level conditions, side loads, hazardous conditions, experience of personnel, etc. The operator and other personnel must read and understand the operator manual before operating this machine. Rules for safe operation of equipment must be adhered to at all times.

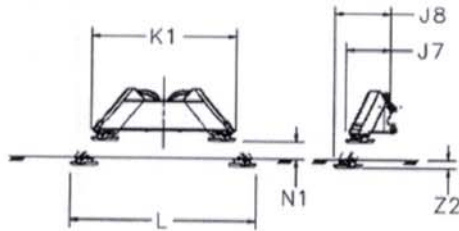
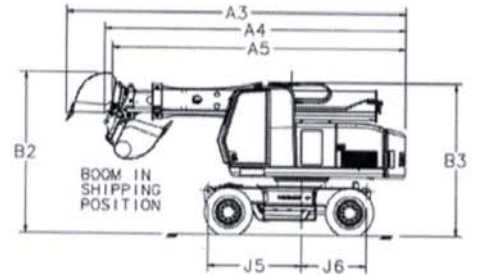
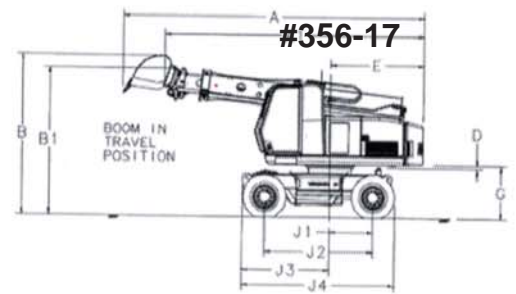
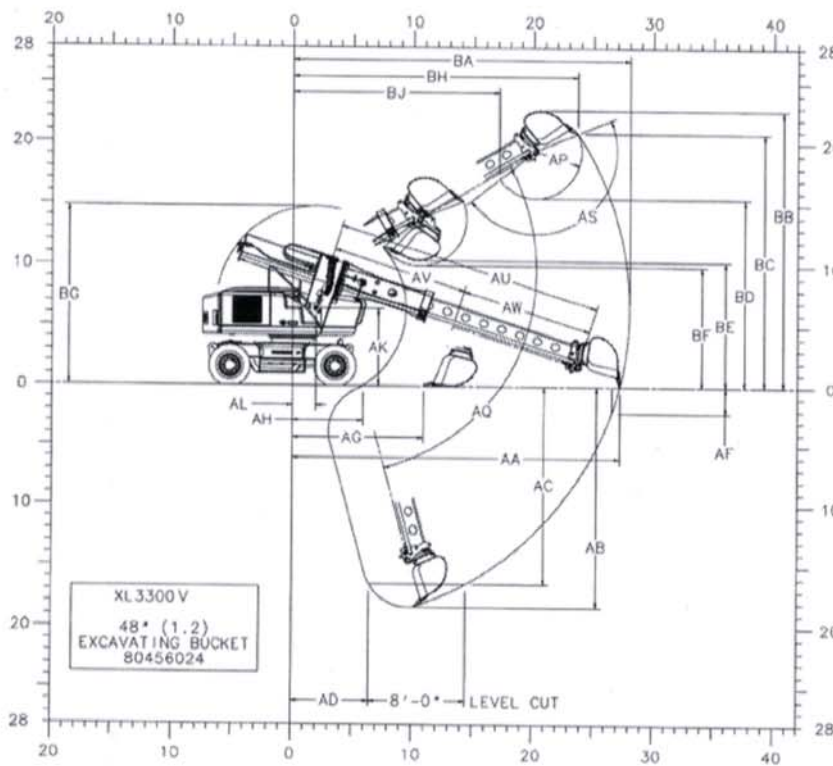

OUTRIGGER OPTION

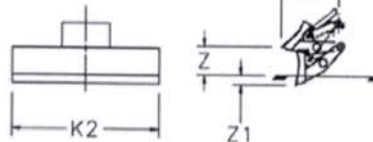

BLADE OPTION

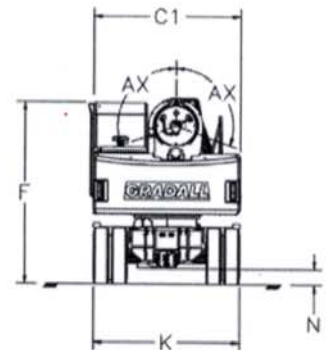

Dimensions

- A** Overall length with bucket open (travel position): 24'3" (7.4)
- A1** Overall length without bucket (travel position): 20'11" (6.4)
- A3** Overall length with bucket open (shipment position): 24'6" (7.5)
- A4** Overall length with bucket closed (shipment position): 21'9" (6.6)
- A5** Overall length without bucket (shipment position): 21'3" (6.5)
- B** Overall height with bucket open (travel position): 12'10" (3.9)
- B1** Overall height without bucket (travel position): 11'10" (3.6)
- B2** Overall height with bucket open (shipment position): 11'6" (3.5)
- B3** Overall height without bucket (shipment position): 10'11" (3.3)
- C1** Width of upperstructure: 8'6" (2.6)
- D** Minimum clearance, upperstructure to undercarriage: 3" (78 mm)
- E** Swing clearance, rear of upperstructure: 7'6" (2.3)
- F** Top of cab to groundline: 10'7" (3.2)
- G** Clearance, upperstructure to groundline: 4'2" (1.3)
- J1** Axis of rotation to centerline of fixed axle: 3'6" (1.1)
- J2** Wheelbase of undercarriage: 8'9" (2.7)
- J3** Axis of rotation to front of undercarriage: 7'0" (2.1)
- J4** Nominal overall length of undercarriage: 12'3" (3.7)
- J5** Axis of rotation to front option attachment pin: 6'9" (2.1)
- J6** Axis of rotation to rear option attachment pin: 4'9" (1.4)
- J7** Outrigger length, attachment pin to pad in up position: 2'7" (0.8)
- J8** Outrigger length, attachment pin to pad in down position: 3'3" (1.0)
- J9** Blade length, attachment pin across blade in up position: 3'4" (1.0)
- K** Overall width undercarriage: 8'6" (2.6)
- K1** Overall width outrigger (up position): 8'4" (2.5)
- K2** Overall width blade: 8'6" (2.7)
- L** Overall width outrigger (down position): 10'8" (3.3)
- N** Ground clearance (per SAE J1234): 11" (275 mm)
- N1** Ground clearance (outrigger option): 12" (300 mm)
- Z** Blade above ground (option): 1'8" (505 mm)
- Z1** Depth below ground level of blade (option): 7" (166 mm)
- Z2** Depth below ground level of outrigger (option): 6" (142 mm)
- AA** Maximum radius at groundline: 27'3" (8.3)
- AB** Maximum digging depth: 18'5" (5.6)
- AC** Maximum depth for 8' level cut: 16'6" (5.0)
- AD** Minimum radius of 8' level cut at depth "AC": 6'5" (2.0)
- AF** Maximum depth of vertical wall which can be excavated: 2'3" (0.7)
- AG** Minimum level cut radius with bucket flat on groundline: 10'11" (3.3)
- AH** Minimum radius at groundline: 5'10" (1.8)
- AK** Boom pivot to groundline: 6'5" (2.0)
- AL** Boom pivot to axis of rotation: 1'11" (585 mm)
- AP** Bucket tooth radius: 3'10" (1.2)
- AQ** Boom pivot angle: 30° up and 75° dn
- AS** Bucket pivot angle: 165°
- AU** Maximum telescoping boom length (boom pivot to bucket pivot): 22'3" (6.8)
- AV** Minimum telescoping boom length (boom pivot to bucket pivot): 11'3" (3.4)
- AW** Telescoping boom travel: 11'0" (3.4)
- AX** Bucket tilt angle (both sides of center): 110°
- BA** Maximum radius of working equipment: 28'0" (8.5)
- BB** Maximum height of working equipment: 22'8" (6.9)
- BC** Maximum bucket tooth height: 20'10" (6.3)
- BD** Minimum clearance of bucket teeth, with bucket pivot at maximum height: 15'6" (4.7)
- BE** Minimum clearance of fully curled bucket at maximum boom height: 10'5" (3.2)
- BF** Minimum clearance of bucket teeth at maximum boom height: 9'11" (3.0)
- BG** Maximum height of working equipment with bucket below groundline: 14'9" (4.5)
- BH** Radius of bucket teeth at maximum height: 23'9" (7.2)
- BJ** Minimum radius of bucket teeth at maximum bucket pivot height: 17'1" (5.2)

Metric units are meters (m) unless noted.
Machines shown may have optional equipment.

Optional Equipment

Vandalism protection kit including window covers.

Strobe light.

Block heater.

ROPS protective cab.

Auxiliary Hydraulics - Additional hoses and piping for hydraulic powered attachments. [Maximum pressure 4800 psi (33,095 kPa) Maximum flow 30 GPM (114 L/min)]

Attachments

Quick change and reversible buckets fabricated of steel plate, with high strength, low alloy cutting edges and wear strips. Standard attachments available for wide range of applications. Capacities shown are in heaped cu. yd.

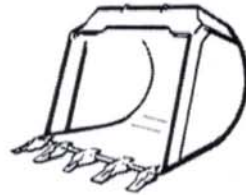

8045-6020	24" (610 mm)	Excavating bucket	Cu. yd.	m ³
8045-6021	30" (762 mm)	Excavating bucket	3/8	0.31
8045-6022	36" (914 mm)	Excavating bucket	1/2	0.41
8045-6023	42" (1.07 m)	Excavating bucket	5/8	0.54
8045-6024	48" (1.22 m)	Excavating bucket	3/4	0.64
			1	0.76

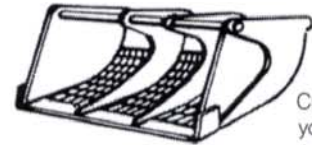

8065-6013	72" (1.83 m)	Dredging bucket	Cu. yd.	m ³
			1 1/8	0.87

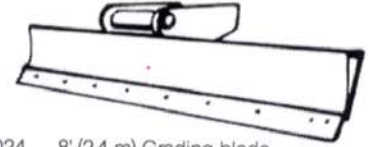

8065-6024 8' (2.4 m) Grading blade

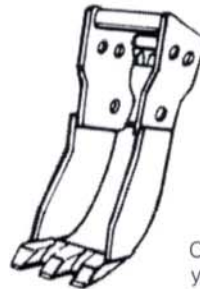

8065-6104	15" (381 mm)	Trenching bucket	Cu. yd.	m ³
8065-6102	21" (533 mm)	Trenching bucket	1/5	0.15
			1/4	0.19

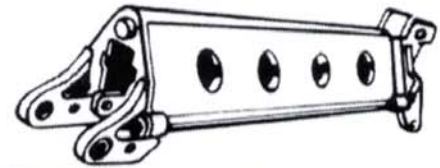

8065-5028 4' (1.2 m) Boom extension

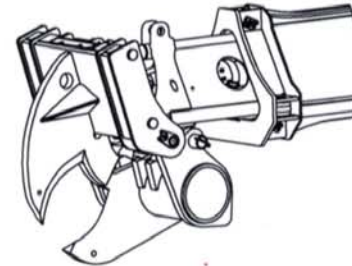

8045-5052 Tree Limb shear attachment

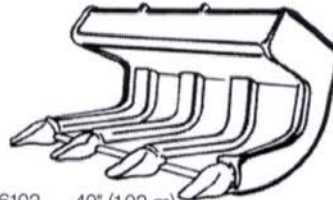

8065-6102	40" (1.02 m)	Pavement removal bucket
8065-6115	18" (0.457 m)	Pavement removal bucket
8065-6116	24" (0.610 m)	Pavement removal bucket
8065-6114	28" (0.711 m)	Pavement removal bucket

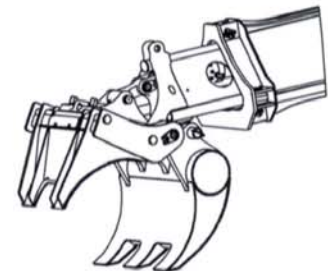

8075-5023 Fixed thumb grapple

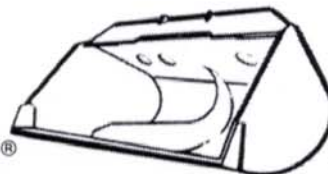

8065-6040	30" (0.762 m)	Ditching bucket	Cu. yd.	m ³
8065-6007	60" (1.52 m)	Ditching bucket	3/8	0.3
8065-6006	66" (1.68 m)	Ditching bucket	7/8	0.73
8065-6002	72" (1.83 m)	Ditching bucket	1	0.76
			1 1/8	0.87

It is Gradall Policy to continually improve its products. Therefore designs, materials and specifications are subject to change without notice and without incurring any liability on units already sold. Units shown may have optional equipment.

GRADALL[®]

406 Mill Ave. SW, New Philadelphia, Ohio 44663
 Phone: 330-339-2211 Fax: 330-339-8468
 www.Gradall.com

Certified ISO 9001





City of Newton, Massachusetts
Office of the Mayor

SETTI D. WARREN
MAYOR

#357-17
Telephone
(617) 796-1100
Telefax
(617) 796-1113
TDD
(617) 796-1089
E-mail
swarren@newtonma.gov

October 30, 2017

Honorable City Council
Newton City Hall
1000 Commonwealth Avenue
Newton Centre, MA 02459

Ladies and Gentlemen:

RECEIVED
Newton City Clerk
2017 OCT 30 PM 2:15
David A. Olson, CMC
Newton, MA 02459

I write to request that your Honorable Council docket for consideration a request to authorize the City to enter into a lease agreement authorizing the delivery, implementation, management and support of a Student Information System (SIS) for the Newton Public Schools (NPS).

Proposals were submitted by 5/18/17, and seven (7) proposers duly submitted proposals. Based on the evaluations and price proposals Follett School Solutions, Inc. was awarded the contract as the most advantageous responsive and responsible proposer. The City is currently negotiating the final plan of services with Follett and NPS.

In conjunction with the procurement of the SIS system, NPS is seeking upgrades to its Cisco-manufactured hardware and software system. The Cisco system regulates NPS-owned computers and provides connection to the internet, maintains a firewall, and by filtering assures that only appropriate websites can be accessed. It maintains the database for SIS. NPS is already invested in the Cisco based system, so any change to a different provider would be impracticable.

The upgrade will be for both hardware and software and is expected to take 3 years, at an annual cost of \$237,565, or \$712,696 for the implementation of the entire project. NPS has been offered a 0% financing by a Delaware LLC, De Lage Landen Public Finance Company. The financing agreement is called an Equipment Lease Purchase Agreement. Although called a "lease" it is basically an installment loan. The amount of the loan is being negotiated among the LLC, NPS and Legal.

Thank you for your consideration of this matter.

Sincerely,

Setti D. Warren
Mayor



SETTI D. WARREN
MAYOR

City of Newton, Massachusetts
Office of the Mayor

#355-17

Telephone
(617) 796-1100
Telefax
(617) 796-1113

TDD
(617) 796-1089

E-mail
swarren@newtonma.gov

October 30, 2017

Honorable City Council
Newton City Hall
1000 Commonwealth Avenue
Newton Centre, MA 02459

Ladies and Gentlemen:

I write to request that your Honorable Council docket for consideration a request to authorize the appropriation of the sum of \$1,200,000 and authorize a general obligation borrowing of an equal amount for the replacement of Ladder 2. This item is included in the FY19-FY23 Capital Improvement Plan.

Thank you for your consideration of this matter.

Sincerely,

Setti D. Warren
Mayor

RECEIVED
Newton City Clerk
2017 OCT 30 PM 2: 17
David A. Olson, CMC
Newton, MA 02459



#355-17
530 JOHN DIETSCH BOULEVARD
NORTH ATTLEBORO, MA 02763-1080
PHONE: 508.695.7138
FAX: 508.699.6842
PARTS: 1.800.347.3878

October 27, 2017

Chief Bruce Proia
City of Newton Fire Department
1164 Center Street
Newton, MA 02159

Chief Proia,

Thank you for the opportunity to provide you with a quote on a new E-One HM100 Ladder Truck. The truck is configured utilizing the same specifications as Ladder 1. The major changes included converting to an air ride suspension, zinc coating on the frame and torque box, lowering the dash to match E-3, and deleting the Firecom system. I kept the generator at a 10KW for now, because dropping it to 8KW was only going to save a few hundred dollars. You have to drop to the 6KW (smaller size unit) to see significant savings.

I will send you the line item specs and the drawings to review. If you would like to have another meeting to discuss, I am happy to come up and meet with you at your convenience. The cost of this unit for purchase in 2018 through the HGAC program would be \$1,025,000. This would include the same basic equipment as provided on L-1. I did include a \$25,000 allowance for equipment, tool mounting, etc.. as well as the standard items such as the flashlights, lettering, wheel chocks, ground ladders, stokes basket, etc.. as is noted in the specs. The price also includes the 5 year warranty.

Please let me know if you have any questions or would like to schedule a follow up meeting to discuss in further detail.

Best Regards,

A handwritten signature in black ink, appearing to read "MAM", written over a white background.

Mark MacDonald
President
Greenwood Emergency Vehicles, LLC



SETTI D. WARREN
MAYOR

City of Newton, Massachusetts
Office of the Mayor

#345-17
Telephone
(617) 796-1100
Facsimile
(617) 796-1113
TDD/TTY
(617) 796-1089
E-mail
swarren@newtonma.gov

October 20, 2017

Honorable City Council
Newton City Hall
1000 Commonwealth Avenue
Newton, MA 02459

Ladies and Gentlemen:

I write to request that your Honorable Council docket for consideration a request to expend \$22,460.00 from the Massachusetts Emergency Management Agency (MEMA) grant for the purposes of purchasing equipment and other related items for the new Emergency Operations Center (EOC) at Fire Station 3 and Headquarters. Please see the accompanying letter from Chief Bruce Proia.

Thank you for your consideration of this matter.

Very truly yours,

Setti D. Warren
Mayor

RECEIVED
Newton City Clerk
2017 OCT 20 AM 9:46
David A. Olson, CMC
Newton, MA 02459

1000 Commonwealth Avenue Newton, Massachusetts 02459

www.newtonma.gov



DEDICATED TO COMMUNITY EXCELLENCE



Bruce A. Proia
Chief

CITY OF NEWTON, MASSACHUSETTS
FIRE DEPARTMENT HEADQUARTERS

1164 Centre Street, Newton Center, MA 02459-1584
Chief: (617) 796-2210 Fire Prevention: (617) 796-2230
FAX: (617) 796-2211 EMERGENCY: 911



Setti D. Warren
Mayor

October 17, 2017

Maureen Lemieux
Chief Financial Officer
City of Newton
1000 Commonwealth Ave
Newton, MA 02459

Maureen,

I respectfully request to docket funding of \$22,460.00 from Massachusetts Emergency Management Agency (MEMA) Grant.

The funding is going to be used to purchase equipment and related items for the new Emergency Operations Center (EOC). Such equipment to purchase will be 10 laptop computers, printer for EOC, software for laptops and the annual LUA software program for Emergency Management.

The Grant is a reimbursement grant, therefore, we would respectfully request authorization to expend the grant and when refunded by MEMA to replenish our account of expenditure.

Thank you for your consideration to this request.

Respectfully,

A handwritten signature in black ink, appearing to read "B. Proia".

Bruce Proia
Chief of Department



City of Newton, Massachusetts
Office of the Mayor

SETTI D. WARREN
MAYOR

Telephone
(617) 796-1100
Telefax
(617) 796-1113
TDD
(617) 796-1089

E-mail

swar@newtonma.gov

RECEIVED
Newton City Clerk
2017 NOV -2 AM 8:49
DAVID A. OLSON, CMC
Newton, MA 02459

November 1, 2017

Honorable City Council
Newton City Hall
1000 Commonwealth Avenue
Newton Centre, MA 02459

Ladies and Gentlemen:

I write to request that your Honorable Council amend my docket request to replace both the City's financial software, as well as the permitting and licensing software, with a request to replace only the financial software. Additionally, please amend the funding request from \$2,059,012 to \$1,507,105.

While it is imperative that the City move forward with the replacement of the financial software as soon as possible, we are going to revisit the permitting/licensing software solution.

Thank you for your consideration of this matter.

Sincerely,

Setti D. Warren
Mayor



Setti D. Warren, Mayor

Joseph P. Mulvey
Chief Information Officer

CITY OF NEWTON, MASSACHUSETTS

DEPARTMENT OF INFORMATION TECHNOLOGY

Telephone (617) 796-1180
Facsimile (617) 796-1196
TDD/tty # (617) 796-1089

To: Maureen Lemieux
From: Joseph Mulvey, IT Department
Date: November 1, 2017
Re: Request for Funding to Upgrade our Financial and Permitting Systems

RECEIVED
Newton City Clerk
2017 NOV -2 AM 8:51
David A. Olson, CMO
Newton, MA 02459

Hello Maureen,

As previously discussed, and on behalf of the Information Technology Department as well as to the benefit of the entire City of Newton, I am respectfully requesting funding to upgrade our Financial System to Tyler Technology's Munis.

My justification is as follows:

Financial Upgrade

- We created a Financial System Replacement Committee comprised of key representatives of many departments covering the myriad varying interests and requirements of a municipal financial information system. Concerns of the group were listed and addressed in our many meetings.
- We have had over a dozen demonstrations by Tyler Technologies, the owners of Munis software; we have had broad overview demonstrations for large groups such as the steering committee as well as very task specific demonstrations explicitly tailored for various audiences such as the Comptroller, Purchasing, School and Retirement departments.
- We strongly believe that using Munis for "both sides of the ledger" will provide significant advantages to the city both in productivity as well as in our ability to best serve the public. Consolidation of these silos will lead to an elimination of bridges spanning both sides of the general ledger bringing value in the form of cost savings, efficiency and reduced administrative tasks.
- Numerous meetings were held with our existing Financial System specialists to discuss the many customizations to our existing system and to understand how each and every concern would be addressed by Munis. The results were satisfying.
- With over 160 Massachusetts municipalities using Munis right now, the system is a well-oiled machine when it comes to meeting the needs of Mass cities and towns as well as the laws of the Commonwealth.
- Among our committee was former IT and FIS Director Ann Cornaro bringing her 44 years of financial software experience to the table. In an informal discussion, our former City Comptroller strongly encourages us to pursue the Munis solution.

The total of this request amounts to \$1,507,105.

Maureen, as always, thank you for your consideration.

I am readily prepared to supply further details as required by you or the City Council.

If I may be of further assistance in answering any questions or for further clarification, I am always available at your convenience.

Thank you,
Joe

A handwritten signature in black ink that reads "Joseph P. Mulvey". The signature is written in a cursive style with a large, prominent initial "J".