

## Infiltration Trench Factsheet

**Infiltration Trench** is a practice that provides temporary storage of runoff using the void spaces within the soil/sand/gravel mixture that is used to backfill the trench for subsequent infiltration into the surrounding subsoils. Performance results for the infiltration trench can be used for all subsurface infiltration practices including systems that include pipes and/or chambers that provide temporary storage. Also, the results for this BMP type can be used for bio-retention systems that rely on infiltration when the majority of the temporary storage capacity is provided in the void spaces of the soil filter media and porous pavements that allow infiltration to occur. General design specifications for infiltration trench systems are provided in the most recent version of *The New Hampshire Stormwater Manual, Volume 2: Post-Construction Best Management Practices Selection and Design*.

### Sample Design

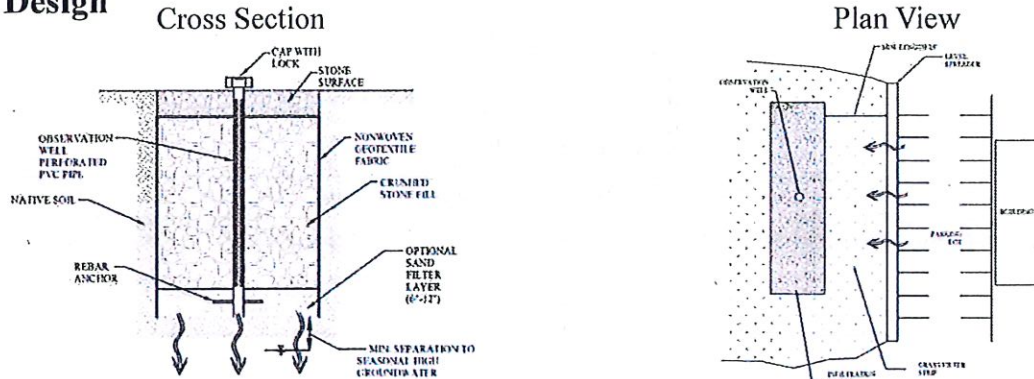

Examples images from the *New Hampshire Stormwater Manual, Volume 2*, p. 86

### Pollutant Export Rate by Land Use<sup>1</sup>

Source Category by Land Use	Land Surface Cover	P Load Export Rate <sup>1</sup> (lbs./acre/year)	N Load Export Rate <sup>2</sup> (lbs./acre/year)
Commercial (COM) and Industrial (IND)	Directly connected impervious	1.78	15
Multi-Family (MFR) and High-Density Residential (HDR)	Directly connected impervious	2.32	14.1
Medium-Density Residential (MDR)	Directly connected impervious	1.96	14.1
Low-Density Residential (LDR) - "Rural"	Directly connected impervious	1.52	14.1

<sup>1</sup> From NH Small MS4 General Permit, Appendix F

### General Equations

Physical Storage Capacity: Depth of Runoff * Drainage Area
Cost: Physical Storage Capacity * Cost Index * Adjustment Factor <sup>1</sup>
Yearly Pollutant Removal: Pollutant Load Export Rate * Drainage Area * Efficiency

### Cost

Infiltration Trench System	Materials and Installation Cost (\$/ft <sup>3</sup> ) (2018)	Design Cost (\$/ft <sup>3</sup> ) (2018)	Total Cost (\$/ft <sup>3</sup> ) (2018) <sup>1,2</sup>
Rural	8.19	4.41	12.60
Mixed	16.38	8.82	25.20
Urban	24.57	13.23	37.80

<sup>1</sup> EPA Memorandum "Methodology for developing cost estimates for Opti-Tool." February 20, 2016

<sup>2</sup> Converted from 2010 to 2018 dollars using U.S. Department of Labor (USDOL). (2012). Bureau of Labor Statistics consumer price index inflation calculator. [http://www.bls.gov/data/inflation\\_calculator.htm](http://www.bls.gov/data/inflation_calculator.htm)



# BMP Performance Curves for Soil Infiltration Rate: Infiltration Trench

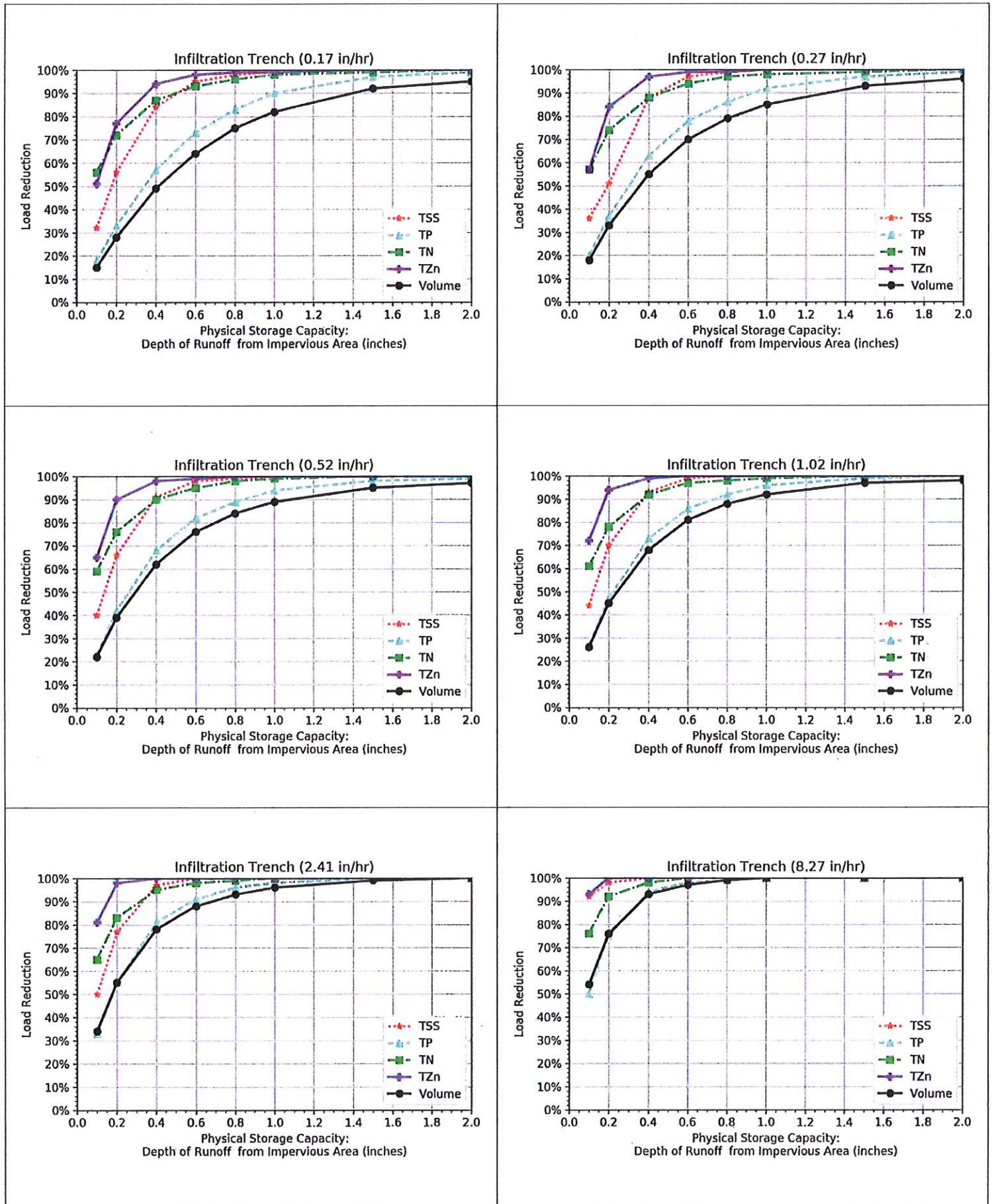

# BMP Performance Tables for Soil Infiltration Rate: Infiltration Trench

		Cumulative Load Reduction				
Infiltration Rate (in/hr)	Depth of Runoff from Impervious Area (inches)	TSS	Phosphorus	Nitrogen	Zinc	Runoff Volume
0.17	0.1	32%	18%	56%	51%	15%
	0.2	56%	33%	72%	77%	28%
	0.4	84%	57%	87%	94%	49%
	0.6	95%	73%	93%	98%	64%
	0.8	98%	83%	96%	99%	75%
	1.0	99%	90%	98%	99%	82%
	1.5	100%	97%	99%	100%	92%
	2.0	100%	99%	100%	100%	95%
0.27	0.1	36%	20%	57%	57%	18%
	0.2	51%	37%	74%	84%	33%
	0.4	88%	63%	88%	97%	55%
	0.6	97%	78%	94%	99%	70%
	0.8	99%	86%	97%	99%	79%
	1.0	100%	92%	98%	100%	85%
	1.5	100%	97%	99%	100%	93%
	2.0	100%	99%	100%	100%	96%
0.52	0.1	40%	23%	59%	65%	22%
	0.2	66%	42%	76%	90%	39%
	0.4	91%	68%	90%	98%	62%
	0.6	98%	82%	95%	99%	76%
	0.8	99%	89%	98%	100%	84%
	1.0	100%	94%	99%	100%	89%
	1.5	100%	98%	100%	100%	95%
	2.0	100%	99%	100%	100%	97%



## BMP Performance Tables for Soil Infiltration Rate: Infiltration Trench

		Cumulative Load Reduction				
Infiltration Rate (in/hr)	Depth of Runoff from Impervious Area (inches)	TSS	Phosphorus	Nitrogen	Zinc	Runoff Volume
1.02	0.1	44%	27%	61%	72%	26%
	0.2	70%	47%	78%	94%	45%
	0.4	93%	73%	92%	99%	68%
	0.6	99%	86%	97%	100%	81%
	0.8	100%	92%	98%	100%	88%
	1.0	100%	96%	99%	100%	92%
	1.5	100%	99%	100%	100%	97%
	2.0	100%	100%	100%	100%	98%
2.41	0.1	50%	33%	65%	81%	34%
	0.2	77%	55%	83%	98%	55%
	0.4	97%	81%	95%	100%	78%
	0.6	100%	91%	98%	100%	88%
	0.8	100%	96%	99%	100%	93%
	1.0	100%	98%	100%	100%	96%
	1.5	100%	100%	100%	100%	99%
	2.0	100%	100%	100%	100%	100%
8.27	0.1	92%	50%	76%	93%	54%
	0.2	98%	75%	92%	100%	76%
	0.4	100%	94%	98%	100%	93%
	0.6	100%	98%	100%	100%	97%
	0.8	100%	99%	100%	100%	99%
	1.0	100%	100%	100%	100%	100%
	1.5	100%	100%	100%	100%	100%
	2.0	100%	100%	100%	100%	100%



## Infiltration Basin Factsheet

**Infiltration Basin** represents a practice that provides temporary surface storage of runoff (e.g. ponding) for subsequent infiltration into the ground. Appropriate practices for use of the surface infiltration performance estimates include infiltration basins, infiltration swales (not conveyance swales), rain gardens, and bio-retention systems that rely on infiltration and provide the majority of storage capacity through surface-ponding. If an infiltration system includes both surface storage through ponding and a lesser storage volume within the void spaces of a coarse filter media, then the physical storage volume capacity used to determine the long-term cumulative phosphorus removal efficiency from the infiltration basin performance curves would be equal to the sum of the surface storage volume and the void space storage volume. General design specifications for infiltration basin systems are provided in the most recent version of *The New Hampshire Stormwater Manual, Volume 2: Post-Construction Best Management Practices Selection and Design*.

### Sample Design

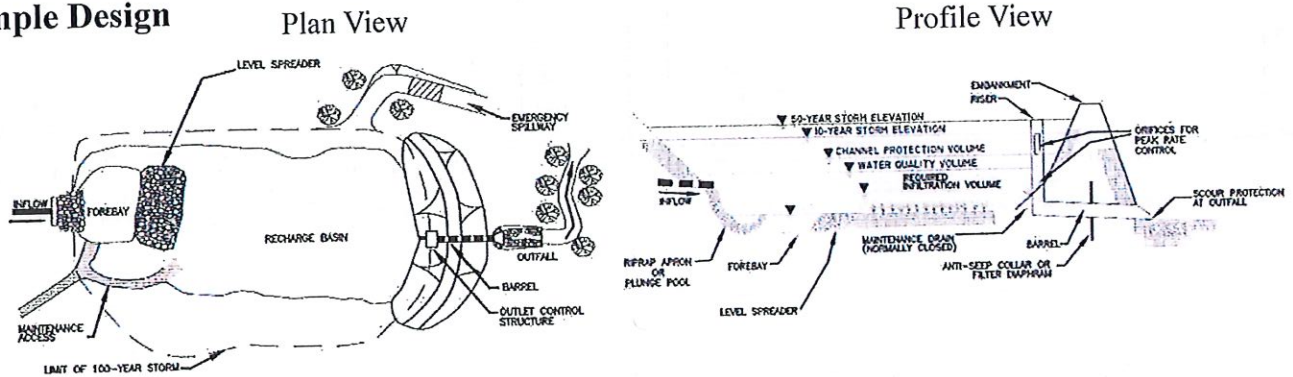

Examples images from the *New Hampshire Stormwater Manual, Volume 2*, p. 90

### Pollutant Export Rate by Land Use<sup>1</sup>

Source Category by Land Use	Land Surface Cover	P Load Export Rate <sup>1</sup> (lbs./acre/year)	N Load Export Rate <sup>2</sup> (lbs./acre/year)
Commercial (COM) and Industrial (IND)	Directly connected impervious	1.78	15
Multi-Family (MFR) and High-Density Residential (HDR)	Directly connected impervious	2.32	14.1
Medium-Density Residential (MDR)	Directly connected impervious	1.96	14.1
Low-Density Residential (LDR) - "Rural"	Directly connected impervious	1.52	14.1

### General Equations

<sup>1</sup> From NH Small MS4 General Permit, Appendix F

Physical Storage Capacity: Depth of Runoff * Drainage Area
Cost: Physical Storage Capacity * Cost Index * Adjustment Factor <sup>1</sup>
Yearly Pollutant Removal: Pollutant Load Export Rate * Drainage Area * Efficiency

### Cost

Infiltration Trench System	Materials and Installation Cost (\$/ft <sup>3</sup> ) (2018)	Design Cost (\$/ft <sup>3</sup> ) (2018)	Total Cost (\$/ft <sup>3</sup> ) (2018) <sup>1,2</sup>
Rural	4.10	2.21	6.30
Mixed	8.19	4.41	12.60
Urban	12.29	6.62	18.90

<sup>1</sup> EPA Memorandum "Methodology for developing cost estimates for Opti-Tool." February 20, 2016

<sup>2</sup> Converted from 2010 to 2018 dollars using U.S. Department of Labor (USDOL). (2012). Bureau of Labor Statistics consumer price index inflation calculator. [http://www.bls.gov/data/inflation\\_calculator.htm](http://www.bls.gov/data/inflation_calculator.htm)





# BMP Performance Curves for Soil Infiltration Rate: Infiltration Basin

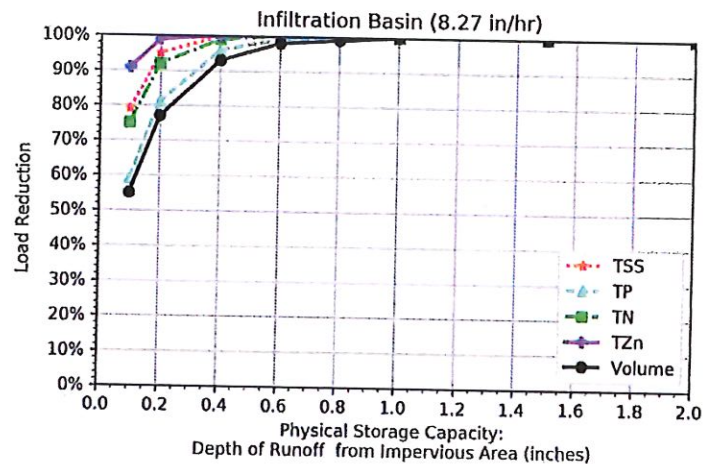
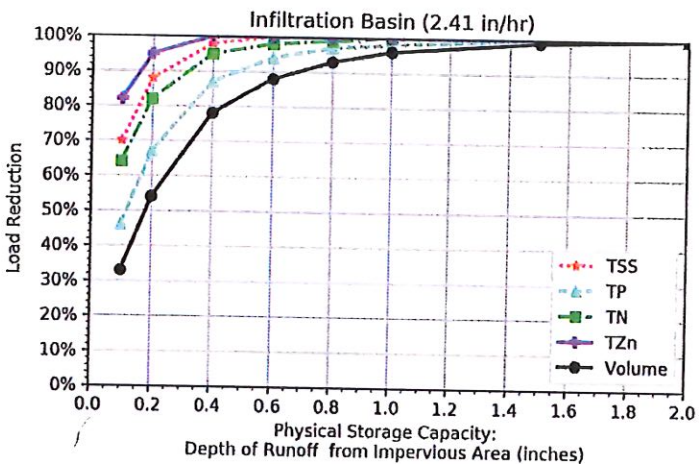
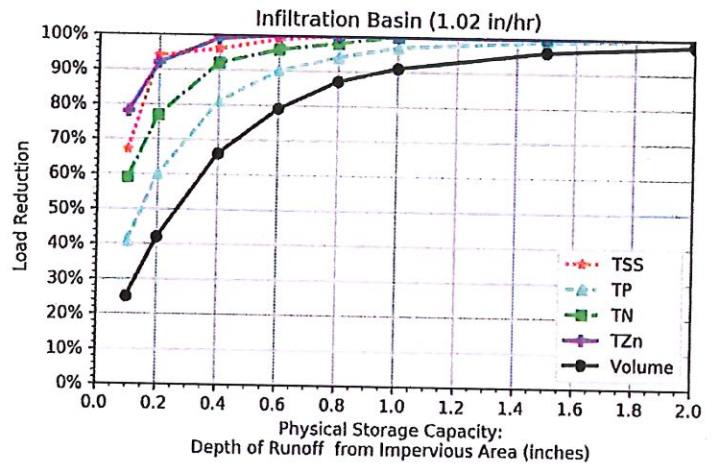
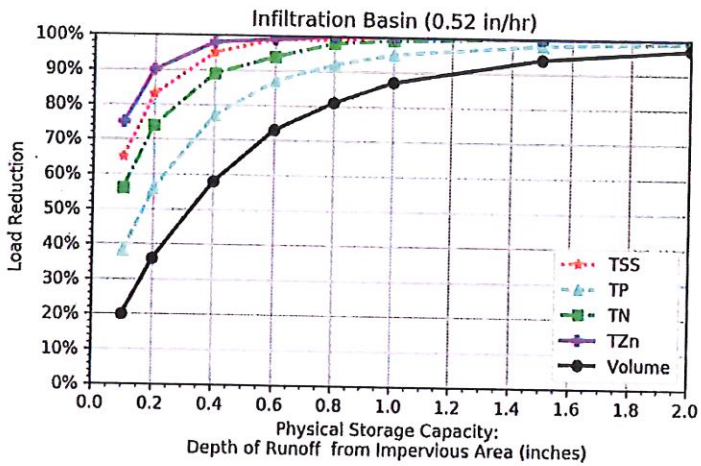
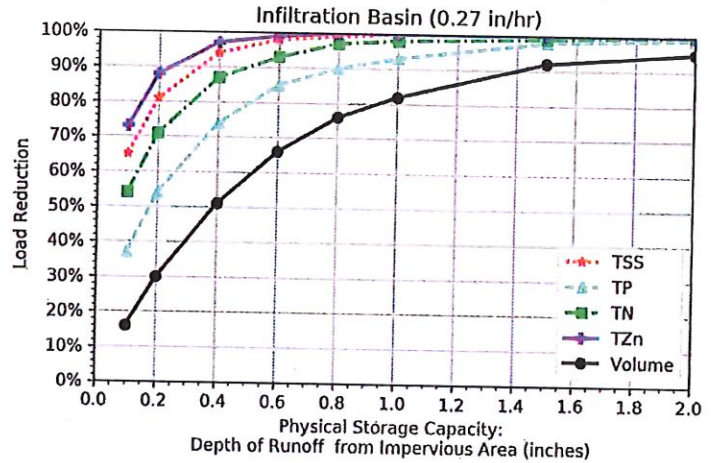
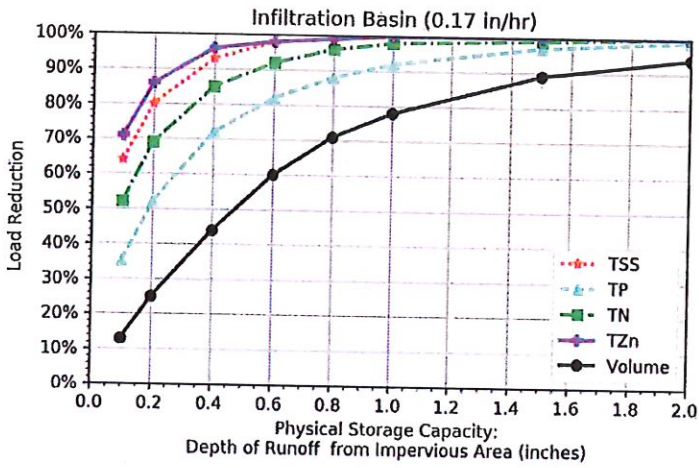



# BMP Performance Tables for Soil Infiltration Rate: Infiltration Basin

		Cumulative Load Reduction				
Infiltration Rate (in/hr)	Depth of Runoff from Impervious Area (inches)	TSS	Phosphorus	Nitrogen	Zinc	Runoff Volume
0.17	0.1	64%	35%	52%	71%	13%
	0.2	80%	52%	69%	86%	25%
	0.4	93%	72%	85%	96%	44%
	0.6	98%	82%	92%	98%	60%
	0.8	99%	88%	96%	99%	71%
	1.0	100%	92%	98%	100%	78%
	1.5	100%	97%	99%	100%	89%
	2.0	100%	99%	100%	100%	94%
0.27	0.1	65%	37%	54%	73%	16%
	0.2	81%	54%	71%	88%	30%
	0.4	94%	74%	87%	97%	51%
	0.6	98%	85%	93%	99%	66%
	0.8	99%	90%	97%	100%	76%
	1.0	100%	93%	98%	100%	82%
	1.5	100%	98%	99%	100%	92%
	2.0	100%	99%	100%	100%	95%
0.52	0.1	65%	38%	56%	75%	20%
	0.2	83%	56%	74%	90%	36%
	0.4	95%	77%	89%	98%	58%
	0.6	99%	87%	94%	99%	73%
	0.8	99%	92%	98%	100%	81%
	1.0	100%	95%	99%	100%	87%
	1.5	100%	98%	100%	100%	94%
	2.0	100%	99%	100%	100%	97%

# BMP Performance Tables for Soil Infiltration Rate: Infiltration Basin

Infiltration Rate (in/hr)	Depth of Runoff from Impervious Area (inches)	Cumulative Load Reduction					Runoff Volume
		TSS	Phosphorus	Nitrogen	Zinc		
1.02	0.1	67%	41%	59%	78%	25%	
	0.2	94%	60%	77%	92%	42%	
	0.4	96%	81%	92%	99%	66%	
	0.6	99%	90%	96%	100%	79%	
	0.8	100%	94%	98%	100%	87%	
	1.0	100%	97%	100%	100%	91%	
	1.5	100%	99%	100%	100%	96%	
	2.0	100%	100%	100%	100%	98%	
2.41	0.1	70%	46%	64%	82%	33%	
	0.2	88%	67%	82%	95%	54%	
	0.4	98%	87%	95%	100%	78%	
	0.6	100%	94%	98%	100%	88%	
	0.8	100%	97%	99%	100%	93%	
	1.0	100%	98%	100%	100%	96%	
	1.5	100%	100%	100%	100%	99%	
	2.0	100%	100%	100%	100%	100%	
8.27	0.1	79%	59%	75%	91%	55%	
	0.2	95%	81%	92%	99%	77%	
	0.4	100%	96%	99%	100%	93%	
	0.6	100%	99%	100%	100%	98%	
	0.8	100%	100%	100%	100%	99%	
	1.0	100%	100%	100%	100%	100%	
	1.5	100%	100%	100%	100%	100%	
	2.0	100%	100%	100%	100%	100%	



## Biofiltration Factsheet

**Biofiltration** is a practice that provides temporary storage of runoff for filtering through an engineered soil media. The storage capacity is typically made of void spaces in the filter media and temporary ponding at the surface of the practice. Once the runoff has passed through the filter media it is collected by an under-drain pipe for discharge. The performance curve for this control practice assumes zero infiltration. If a filtration system has subsurface soils that are suitable for infiltration, then user should use either the performance curves for the infiltration trench or the infiltration basin depending on the predominance of storage volume made up by free standing storage or void space storage. Depending on the design of the manufactured or packaged bio-filter systems such as tree box filters may be suitable for using the bio-filtration performance results. Design specifications for biofiltration systems are provided in the most recent version of *The New Hampshire Stormwater Manual, Volume 2: Post-Construction Best Management Practices Selection and Design*.

### Sample Design

Profile view of a Tree Box Filter. The underdrain makes the system one example of a biofiltration system.

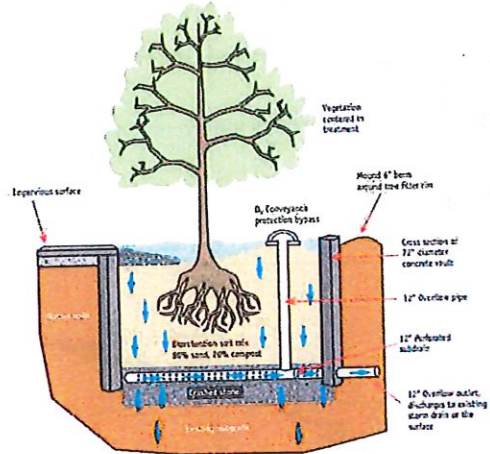

Examples images from the *New Hampshire Stormwater Manual, Volume 2*, p. 116

### Pollutant Export Rate by Land Use<sup>1</sup>

Source Category by Land Use	Land Surface Cover	P Load Export Rate <sup>1</sup> (lbs./acre/year)	N Load Export Rate <sup>2</sup> (lbs./acre/year)
Commercial (COM) and Industrial (IND)	Directly connected impervious	1.78	15
Multi-Family (MFR) and High-Density Residential (HDR)	Directly connected impervious	2.32	14.1
Medium-Density Residential (MDR)	Directly connected impervious	1.96	14.1
Low-Density Residential (LDR) - "Rural"	Directly connected impervious	1.52	14.1

<sup>1</sup> From NH Small MS4 General Permit, Appendix F

### General Equations

Physical Storage Capacity: Depth of Runoff * Drainage Area
Cost: Physical Storage Capacity * Cost Index * Adjustment Factor <sup>1</sup>
Yearly Pollutant Removal: Pollutant Load Export Rate * Drainage Area * Efficiency

### Cost

Infiltration Trench System	Materials and Installation Cost (\$/ft <sup>3</sup> ) (2018)	Design Cost (\$/ft <sup>3</sup> ) (2018)	Total Cost (\$/ft <sup>3</sup> ) (2018) <sup>1,2</sup>
Rural	10.14	5.46	15.60
Mixed	20.28	10.92	31.20
Urban	30.42	16.38	46.80

<sup>1</sup> EPA Memorandum "Methodology for developing cost estimates for Opti-Tool." February 20, 2016

<sup>2</sup> Converted from 2010 to 2018 dollars using U.S. Department of Labor (USDOL). (2012). Bureau of Labor Statistics consumer price index inflation calculator. [http://www.bls.gov/data/inflation\\_calculator.htm](http://www.bls.gov/data/inflation_calculator.htm)

Prepared By:  
University of New Hampshire  
Stormwater Center  
Durham, NH  
[www.unh.edu/unhsc](http://www.unh.edu/unhsc)  
May 2019



## BMP Performance Curve for Biofiltration

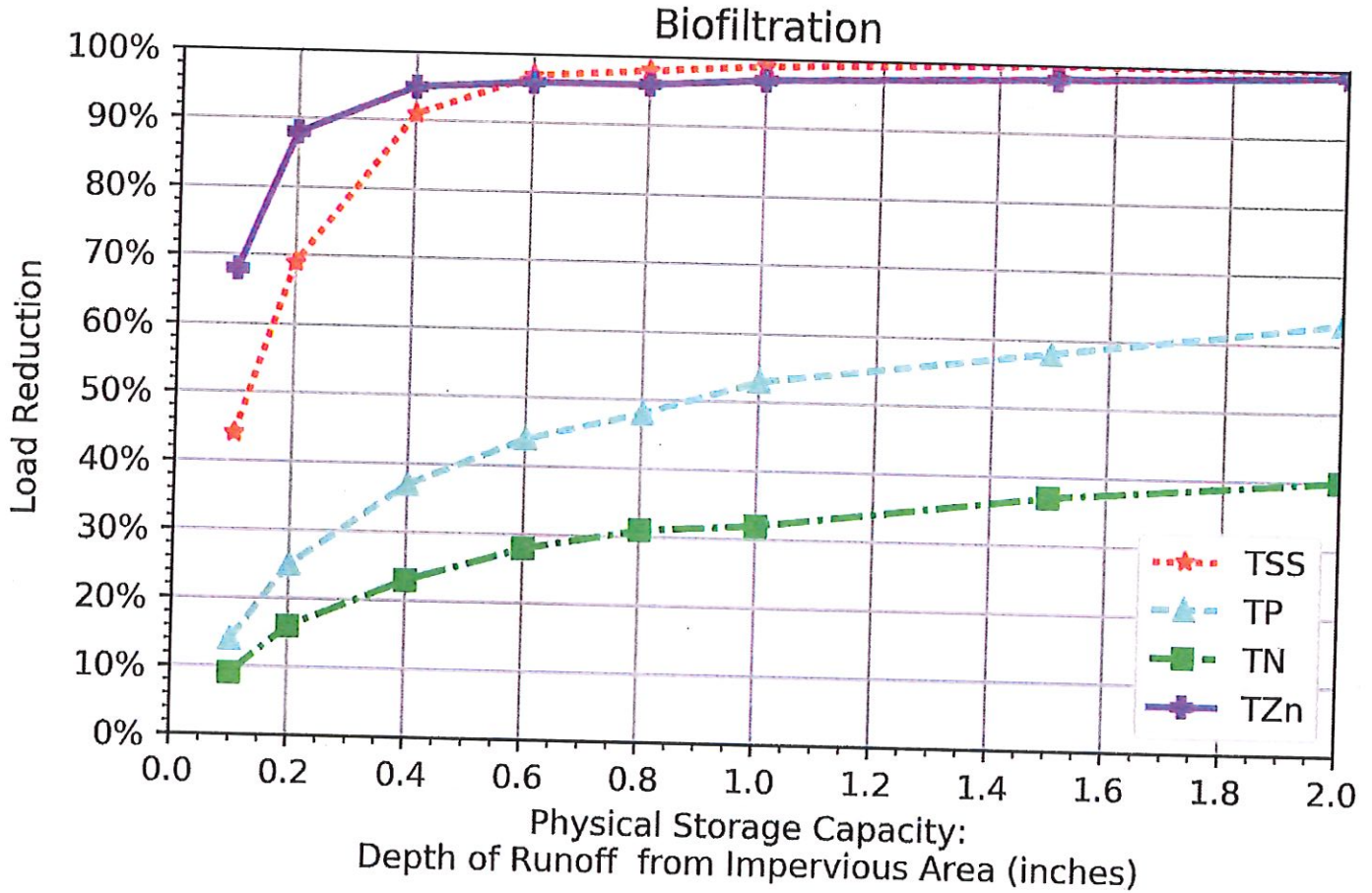

Biofiltration BMP Performance Table								
BMP Capacity: Depth of Runoff from Impervious Area (inches)	0.1	0.2	0.4	0.6	0.8	1.0	1.5	2.0
Cumulative TSS Phosphorus Load Reduction	44%	69%	91%	97%	98%	99%	100%	100%
Cumulative Phosphorus Load Reduction	14%	25%	37%	44%	48%	53%	58%	63%
Cumulative Nitrogen Load Reduction	9%	16%	23%	28%	31%	32%	37%	40%
Cumulative Zinc Phosphorus Load Reduction	68%	88%	95%	96%	96%	97%	98%	99%



## Gravel Wetlands Factsheet

**Gravel Wetlands** consists of one or more flow-through constructed wetland cells, preceded by a forebay. The cells are filled with a gravel media, supporting an organic substrate that is planted with wetland vegetation. During low-flow storm events, the systems is designed to promote subsurface horizontal flow through the gravel media, allowing contact with the root zone of the wetland vegetation. The gravel and planting media support a community of soil microorganisms. Water quality treatment occurs through microbial, chemical, and physical processes within this media. Treatment may also be enhanced by vegetative uptake.. General design specifications for infiltration basin systems are provided in the most recent version of *The New Hampshire Stormwater Manual, Volume 2: Post-Construction Best Management Practices Selection and Design*.

### Sample Design

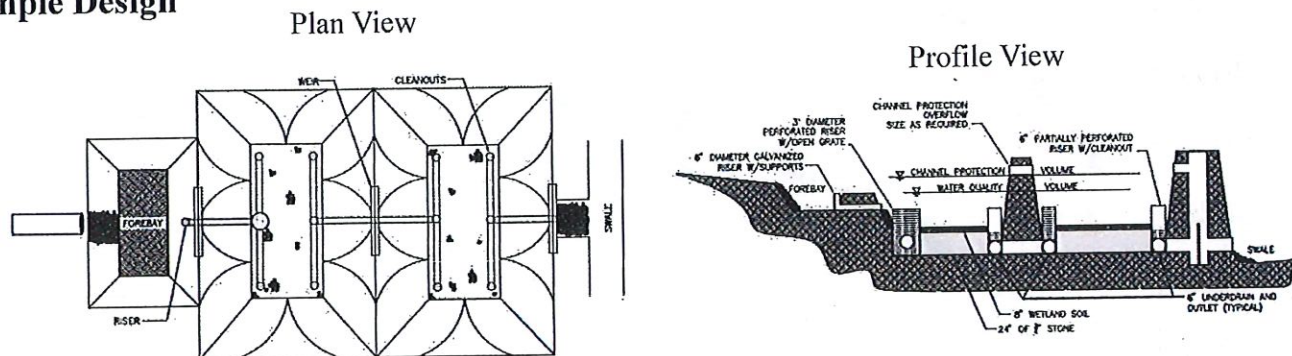

Examples images from the *New Hampshire Stormwater Manual, Volume 2, p. 80*

### Pollutant Export Rate by Land Use<sup>1</sup>

Source Category by Land Use	Land Surface Cover	P Load Export Rate <sup>1</sup> (lbs./acre/year)	N Load Export Rate <sup>2</sup> (lbs./acre/year)
Commercial (COM) and Industrial (IND)	Directly connected impervious	1.78	15
Multi-Family (MFR) and High-Density Residential (HDR)	Directly connected impervious	2.32	14.1
Medium-Density Residential (MDR)	Directly connected impervious	1.96	14.1
Low-Density Residential (LDR) - "Rural"	Directly connected impervious	1.52	14.1

### General Equations

<sup>1</sup> From NH Small MS4 General Permit, Appendix F

Physical Storage Capacity: Depth of Runoff * Drainage Area
Cost: Physical Storage Capacity * Cost Index * Adjustment Factor <sup>1</sup>
Yearly Pollutant Removal: Pollutant Load Export Rate * Drainage Area * Efficiency

### Cost

Infiltration Trench System	Materials and Installation Cost (\$/ft <sup>3</sup> ) (2018)	Design Cost (\$/ft <sup>3</sup> ) (2018)	Total Cost (\$/ft <sup>3</sup> ) (2018) <sup>1,2</sup>
Rural	5.76	3.10	8.86
Mixed	11.52	6.20	17.72
Urban	17.28	9.30	26.58

<sup>1</sup> EPA Memorandum "Methodology for developing cost estimates for Opti-Tool." February 20, 2016

<sup>2</sup> Converted from 2010 to 2018 dollars using U.S. Department of Labor (USDOL). (2012). Bureau of Labor Statistics consumer price index inflation calculator. [http://www.bls.gov/data/inflation\\_calculator.htm](http://www.bls.gov/data/inflation_calculator.htm)

# BMP Performance Curve for Gravel Wetlands

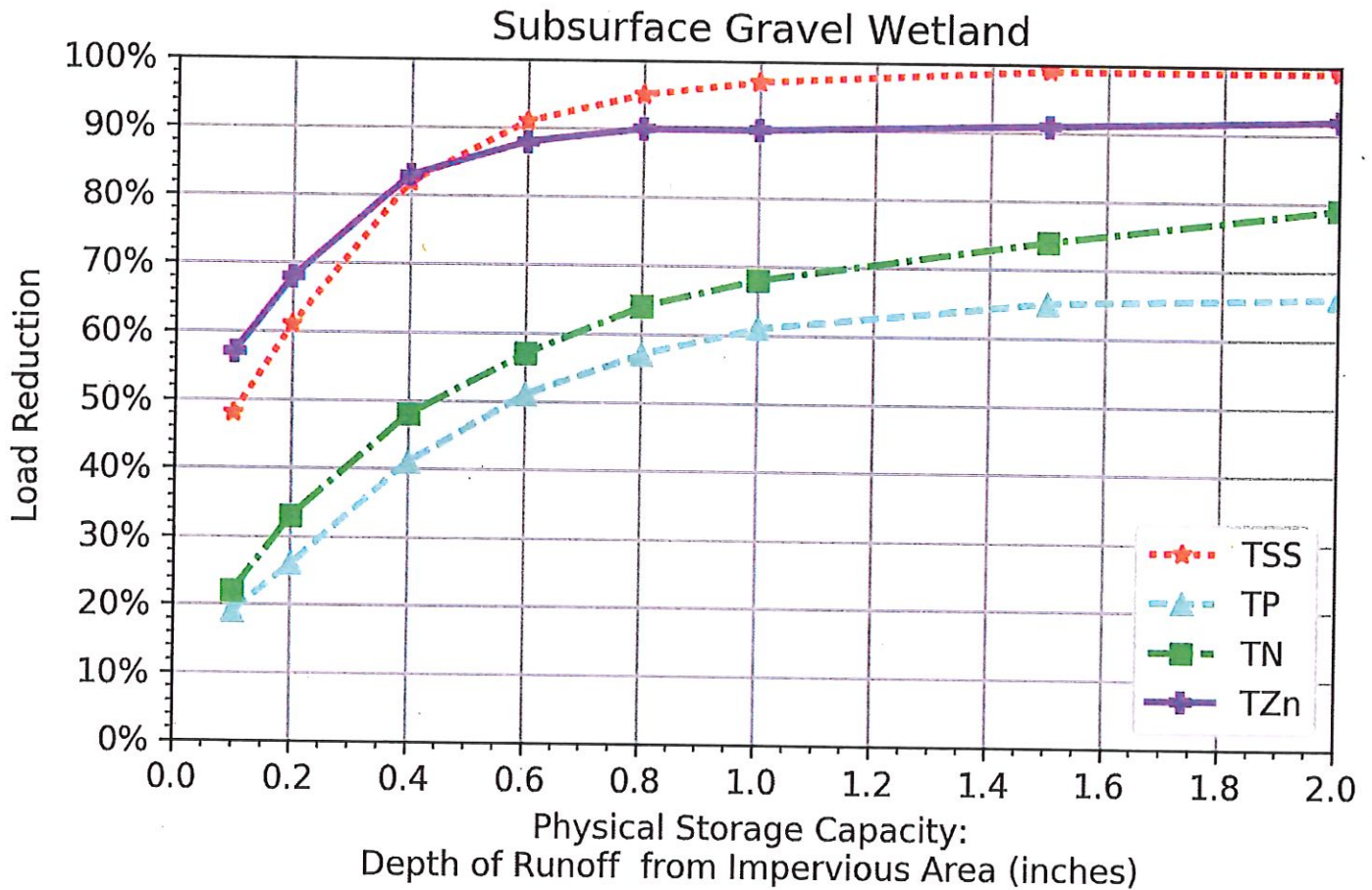

BMP Capacity: Depth of Runoff from Impervious Area (inches)	0.1	0.2	0.4	0.6	0.8	1.0	1.5	2.0
Cumulative TSS Phosphorus Load Reduction	48%	61%	82%	91%	95%	97%	99%	99%
Cumulative Phosphorus Load Reduction	19%	26%	41%	51%	57%	61%	65%	66%
Cumulative Nitrogen Load Reduction	22%	33%	48%	57%	64%	68%	74%	79%
Cumulative Zinc Phosphorus Load Reduction	57%	68%	83%	88%	90%	90%	91%	92%



## Enhanced Biofiltration with Internal Storage Reservoir (ISR) Factsheet

**Enhanced Biofiltration** is a practice that provides temporary storage of runoff for filtering through an engineered soil media, augmented for enhanced phosphorus removal, followed by detention and denitrification in a subsurface internal storage reservoir (ISR) comprised of gravel. Runoff flows are routed through filter media and directed to the underlying ISR via an impermeable membrane for temporary storage. An elevated outlet control at the top of the ISR is designed to provide a retention time of at least 24 hours in the system to allow for sufficient time for denitrification and nitrogen reduction to occur prior to discharge. The design storage capacity for using the cumulative performance curves is comprised of void spaces in the filter media, temporary ponding at the surface of the practice and the void spaces in the gravel ISR. The cumulative phosphorus load reduction curve for this control is intended to be used for systems in which the filter media has been augmented with materials designed and/or known to be effective at capturing phosphorus. If the filter media is not augmented to enhance phosphorus capture, then the phosphorus performance curve for the Bio-Filter should be used for estimating phosphorus load reductions. The University of New Hampshire Stormwater Center (UNHSC) developed the design of this control practice and a design template can be found at UNHSC's website.

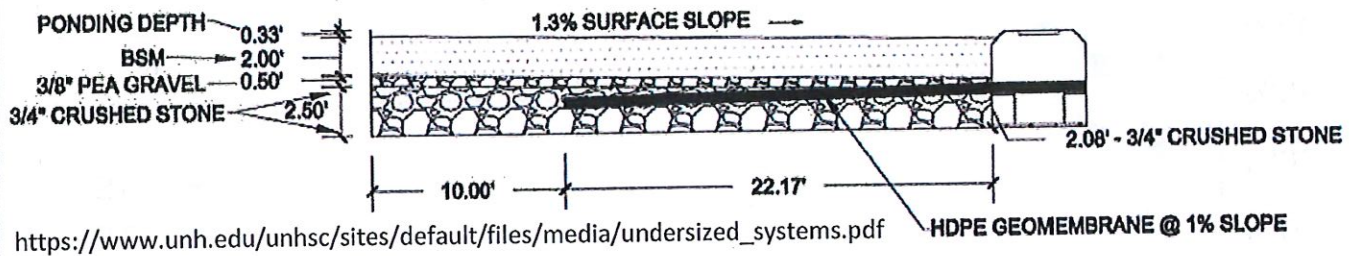

### Pollutant Export Rate by Land Use<sup>1</sup>

Source Category by Land Use	Land Surface Cover	P Load Export Rate <sup>1</sup> (lbs./acre/year)	N Load Export Rate <sup>2</sup> (lbs./acre/year)
Commercial (COM) and Industrial (IND)	Directly connected impervious	1.78	15
Multi-Family (MFR) and High-Density Residential (HDR)	Directly connected impervious	2.32	14.1
Medium-Density Residential (MDR)	Directly connected impervious	1.96	14.1
Low-Density Residential (LDR) - "Rural"	Directly connected impervious	1.52	14.1

<sup>1</sup> From NH Small MS4 General Permit, Appendix F

### General Equations

Physical Storage Capacity: Depth of Runoff * Drainage Area
Cost: Physical Storage Capacity * Cost Index * Adjustment Factor <sup>1</sup>
Yearly Pollutant Removal: Pollutant Load Export Rate * Drainage Area * Efficiency

### Cost

Infiltration Trench System	Materials and Installation Cost (\$/ft <sup>3</sup> ) (2018)	Design Cost (\$/ft <sup>3</sup> ) (2018)	Total Cost (\$/ft <sup>3</sup> ) (2018) <sup>1,2</sup>
Rural	10.24	5.52	15.76
Mixed	20.49	11.03	31.52
Urban	30.73	16.55	47.28

<sup>1</sup> EPA Memorandum "Methodology for developing cost estimates for Opti-Tool." February 20, 2016

<sup>2</sup> Converted from 2010 to 2018 dollars using U.S. Department of Labor (USDOL). (2012). Bureau of Labor Statistics consumer price index inflation calculator. [http://www.bls.gov/data/inflation\\_calculator.htm](http://www.bls.gov/data/inflation_calculator.htm)

# BMP Performance Curve for Enhanced Biofiltration w/ ISR

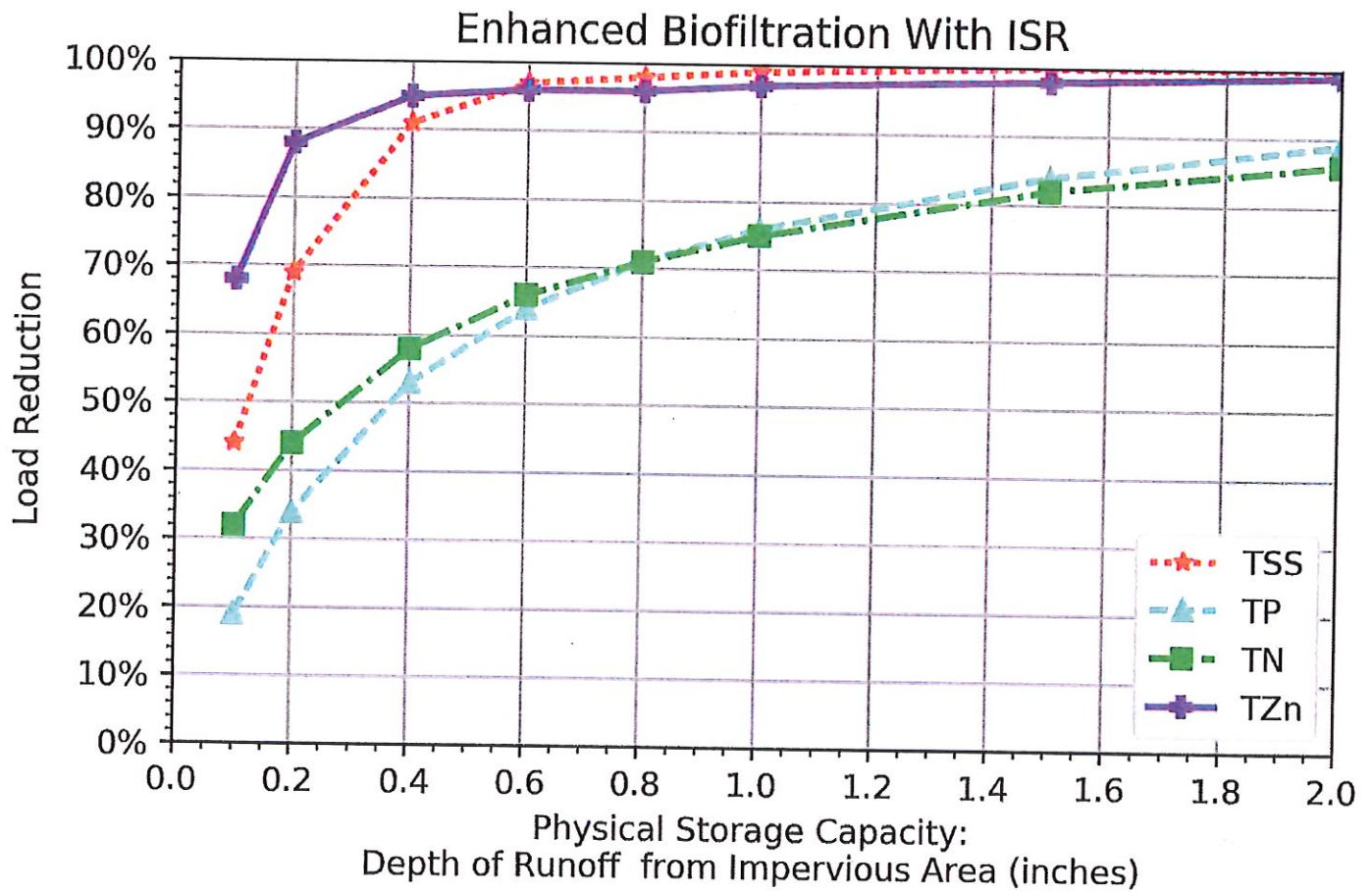

BMP Capacity: Depth of Runoff from Impervious Area (inches)	0.1	0.2	0.4	0.6	0.8	1.0	1.5	2.0
Cumulative TSS Phosphorus Load Reduction	44%	69%	91%	97%	98%	99%	100%	100%
Cumulative Phosphorus Load Reduction	19%	34%	53%	64%	71%	76%	84%	89%
Cumulative Nitrogen Load Reduction	32%	44%	58%	66%	71%	75%	82%	86%
Cumulative Zinc Phosphorus Load Reduction	68%	88%	95%	96%	96%	97%	98%	99%





# BMP Performance Curve for Porous Pavement

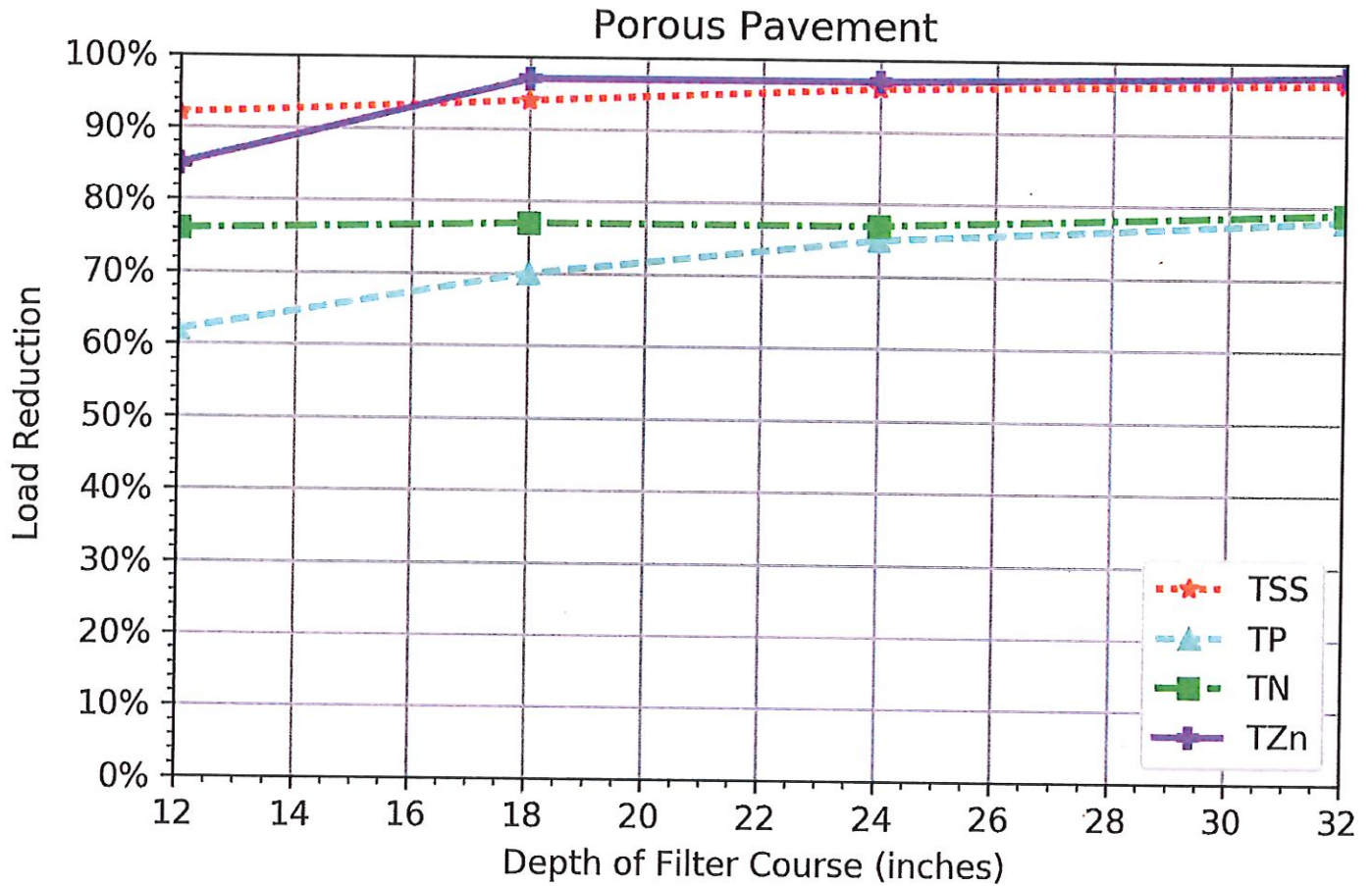

BMP Capacity: Depth of Filter Course Area (inches)	12	18	24	32
Cumulative TSS Phosphorus Load Reduction	92%	94%	96%	97%
Cumulative Phosphorus Load Reduction	62%	70%	75%	78%
Cumulative Nitrogen Load Reduction	76%	77%	77%	79%
Cumulative Zinc Phosphorus Load Reduction	85%	97%	97%	98%



## Grass Swale Factsheet

**Grass Swale** is a system which consists of a vegetated channel with check dams designed to convey and treat stormwater runoff. The design allows filtration through the vegetation and check dams and infiltration through the subsurface soil media. Vegetation for the swale is selected based on mowing requirements, expected design flow, and site soil conditions. The channel should be designed to carry the max design flow within the design depth while preventing erosion within the channel. General design specifications for grass swale systems are provided in the most recent version of *The New Hampshire Stormwater Manual, Volume 2: Post-Construction Best Management Practices Selection and Design*.

### Sample Design

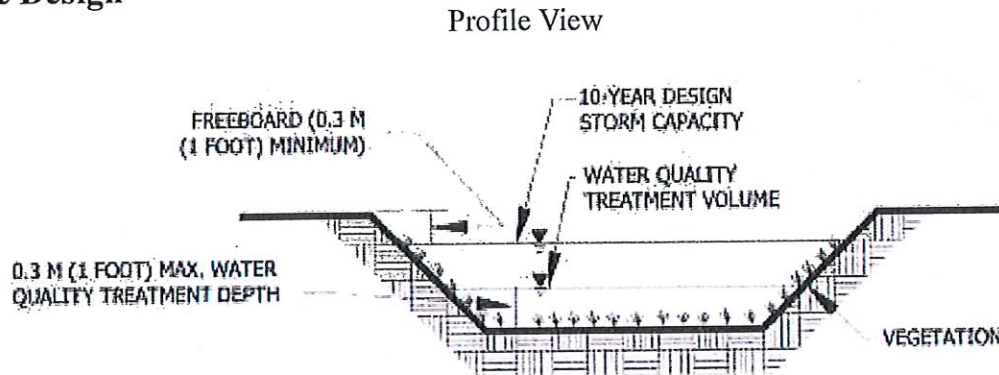

Examples images from the *New Hampshire Stormwater Manual, Volume 2, p. 145*

### Pollutant Export Rate by Land Use<sup>1</sup>

Source Category by Land Use	Land Surface Cover	P Load Export Rate <sup>1</sup> (lbs./acre/year)	N Load Export Rate <sup>2</sup> (lbs./acre/year)
Commercial (COM) and Industrial (IND)	Directly connected impervious	1.78	15
Multi-Family (MFR) and High-Density Residential (HDR)	Directly connected impervious	2.32	14.1
Medium-Density Residential (MDR)	Directly connected impervious	1.96	14.1
Low-Density Residential (LDR) - "Rural"	Directly connected impervious	1.52	14.1

### General Equations

<sup>1</sup> From NH Small MS4 General Permit, Appendix F

Physical Storage Capacity: Depth of Runoff * Drainage Area
Cost: Physical Storage Capacity * Cost Index * Adjustment Factor <sup>1</sup>
Yearly Pollutant Removal: Pollutant Load Export Rate * Drainage Area * Efficiency

<sup>1</sup> EPA Memorandum "Methodology for developing cost estimates for Opti-Tool." February 20, 2016

## BMP Performance Curve for Grass Swale

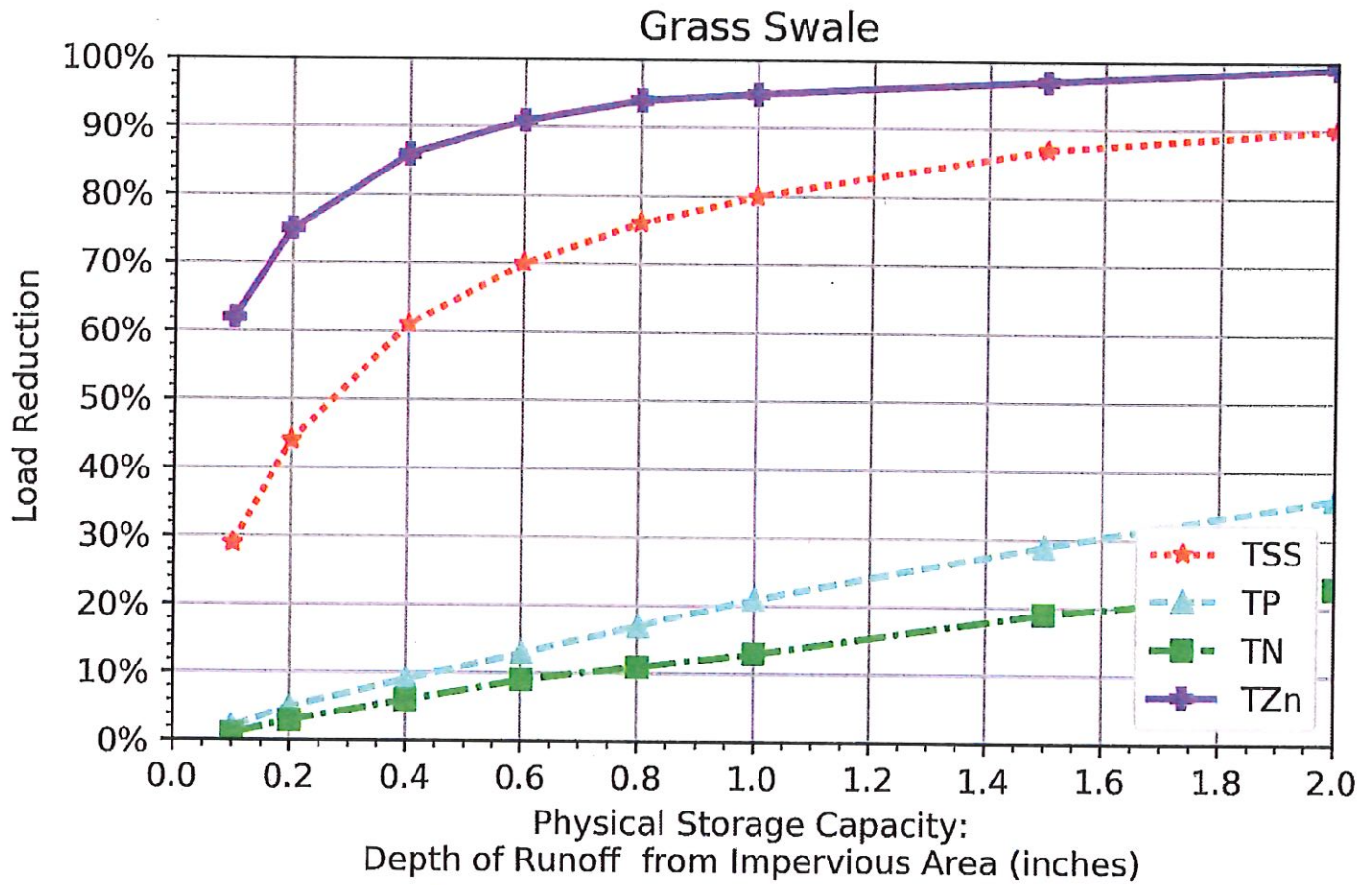

Grass Swale BMP Performance Table								
BMP Capacity: Depth of Runoff from Impervious Area (inches)	0.1	0.2	0.4	0.6	0.8	1.0	1.5	2.0
Cumulative TSS Phosphorus Load Reduction	29%	44%	61%	70%	76%	80%	87%	90%
Cumulative Phosphorus Load Reduction	2%	5%	9%	13%	17%	21%	29%	36%
Cumulative Nitrogen Load Reduction	1%	3%	6%	9%	11%	13%	19%	23%
Cumulative Zinc Phosphorus Load Reduction	62%	75%	86%	91%	94%	95%	97%	99%



## Sand Filter Factsheet

**Sand Filter** is a system which provides filtering of runoff through a sand filter media and temporary storage of runoff within the void spaces prior to discharge by way of an underdrain. Sand filters are generally used for overflow conditions of the primary BMP, and as such often include a pretreatment device to allow coarse settlements to settle out of the water. The top surface of the filter is kept clear of vegetation. General design specifications for sand filter systems are provided in the most recent version of *The New Hampshire Stormwater Manual, Volume 2: Post-Construction Best Management Practices Selection and Design*.

### Sample Design

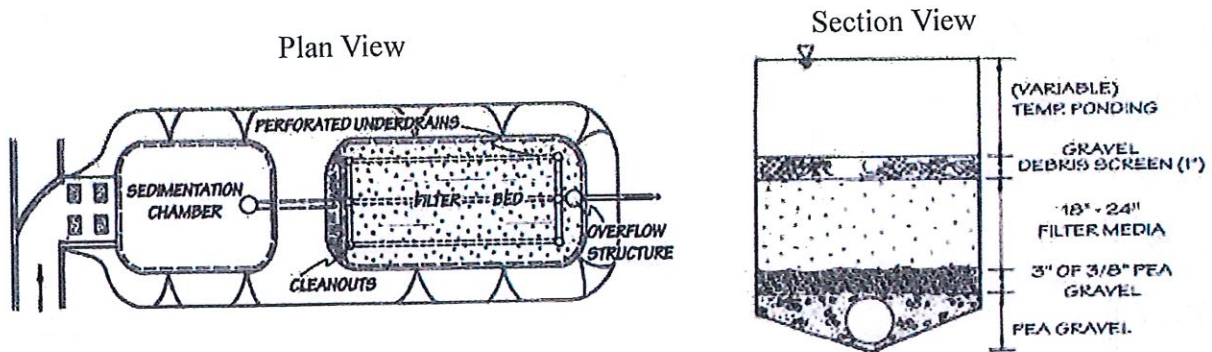

Examples images from the *New Hampshire Stormwater Manual, Volume 2*, p. 104

### Pollutant Export Rate by Land Use<sup>1</sup>

Source Category by Land Use	Land Surface Cover	P Load Export Rate <sup>1</sup> (lbs./acre/year)	N Load Export Rate <sup>2</sup> (lbs./acre/year)
Commercial (COM) and Industrial (IND)	Directly connected impervious	1.78	15
Multi-Family (MFR) and High-Density Residential (HDR)	Directly connected impervious	2.32	14.1
Medium-Density Residential (MDR)	Directly connected impervious	1.96	14.1
Low-Density Residential (LDR) - "Rural"	Directly connected impervious	1.52	14.1

<sup>1</sup> From NH Small MS4 General Permit, Appendix F

### General Equations

Physical Storage Capacity: Depth of Runoff * Drainage Area
Cost: Physical Storage Capacity * Cost Index * Adjustment Factor <sup>1</sup>
Yearly Pollutant Removal: Pollutant Load Export Rate * Drainage Area * Efficiency

### Cost

Infiltration Trench System	Materials and Installation Cost (\$/ft <sup>3</sup> ) (2018)	Design Cost (\$/ft <sup>3</sup> ) (2018)	Total Cost (\$/ft <sup>3</sup> ) (2018) <sup>1,2</sup>
Rural	11.77	6.34	18.10
Mixed	23.53	12.67	36.20
Urban	35.30	19.01	54.30

<sup>1</sup> EPA Memorandum "Methodology for developing cost estimates for Opti-Tool." February 20, 2016

<sup>2</sup> Converted from 2010 to 2018 dollars using U.S. Department of Labor (USDOL). (2012). Bureau of Labor Statistics consumer price index inflation calculator. [http://www.bls.gov/data/inflation\\_calculator.htm](http://www.bls.gov/data/inflation_calculator.htm)

Prepared By:  
University of New Hampshire  
Stormwater Center  
Durham, NH  
[www.unh.edu/unhsc](http://www.unh.edu/unhsc)  
May 2019



## BMP Performance Curve for Sand Filter

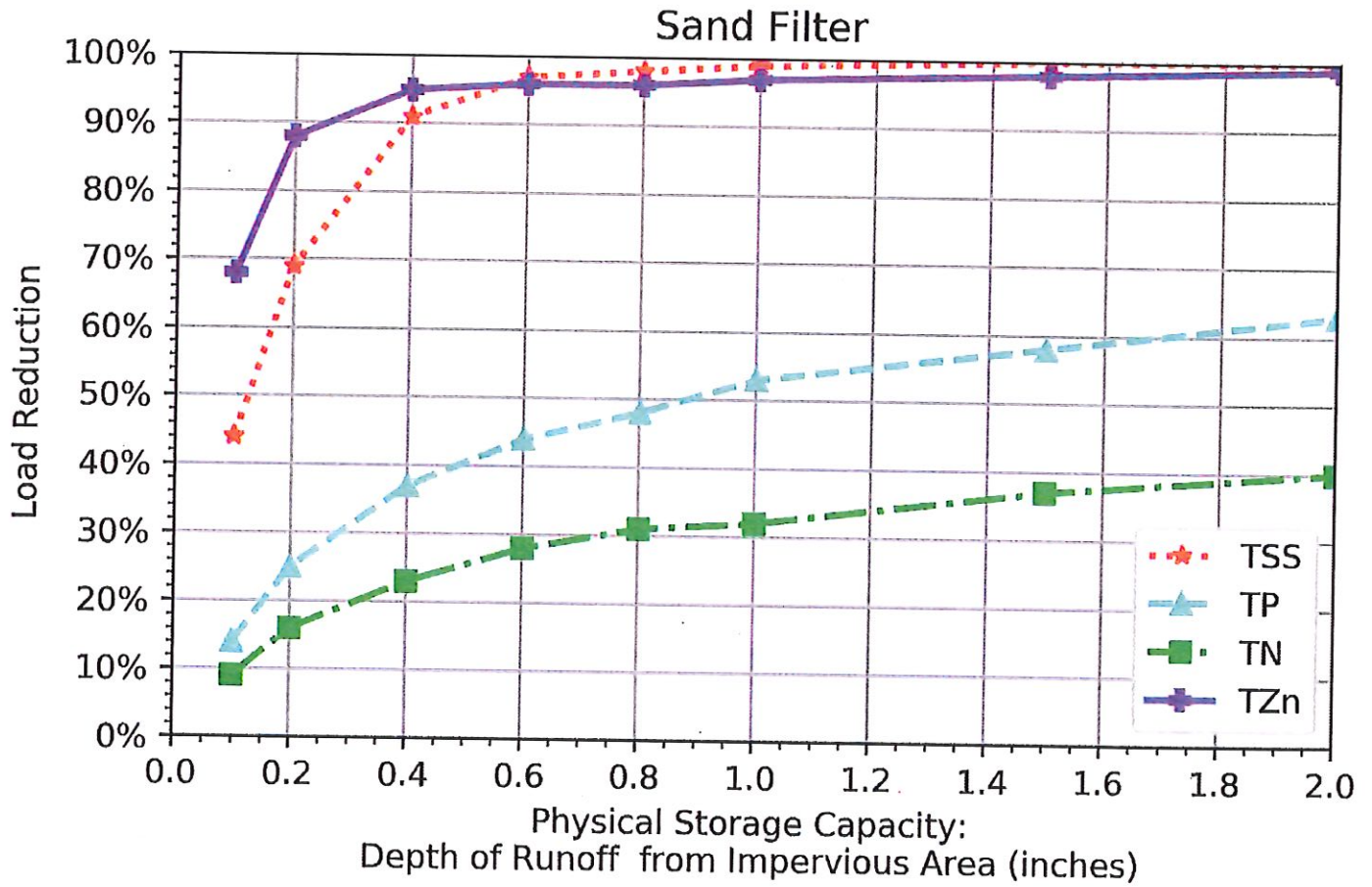

Sand Filter BMP Performance Table								
BMP Capacity: Depth of Runoff from Impervious Area (inches)	0.1	0.2	0.4	0.6	0.8	1.0	1.5	2.0
Cumulative TSS Phosphorus Load Reduction	44%	69%	91%	97%	98%	99%	100%	100%
Cumulative Phosphorus Load Reduction	14%	25%	37%	44%	48%	53%	58%	63%
Cumulative Nitrogen Load Reduction	9%	16%	23%	28%	31%	32%	37%	40%
Cumulative Zinc Phosphorus Load Reduction	68%	88%	95%	96%	96%	97%	98%	99%



## Wet Pond Factsheet

**Wet Pond** is a class of systems designed to maintain a permanent pool of water year-round. The pool allows for pollutant removal via settling, biological uptake, and decomposition. This allows the system to treat both sediment loads and its commonly associated pollutants along with treating dissolved nutrients through the pond's biological processes. For areas where water temperature is a concern, an underdrained gravel trench in the bench area around the permanent pool can allow for the extended release of stormwater, minimizing risk of clogging. General design specifications for wet pond systems are provided in the most recent version of *The New Hampshire Stormwater Manual, Volume 2: Post-Construction Best Management Practices Selection and Design*.

### Sample Design

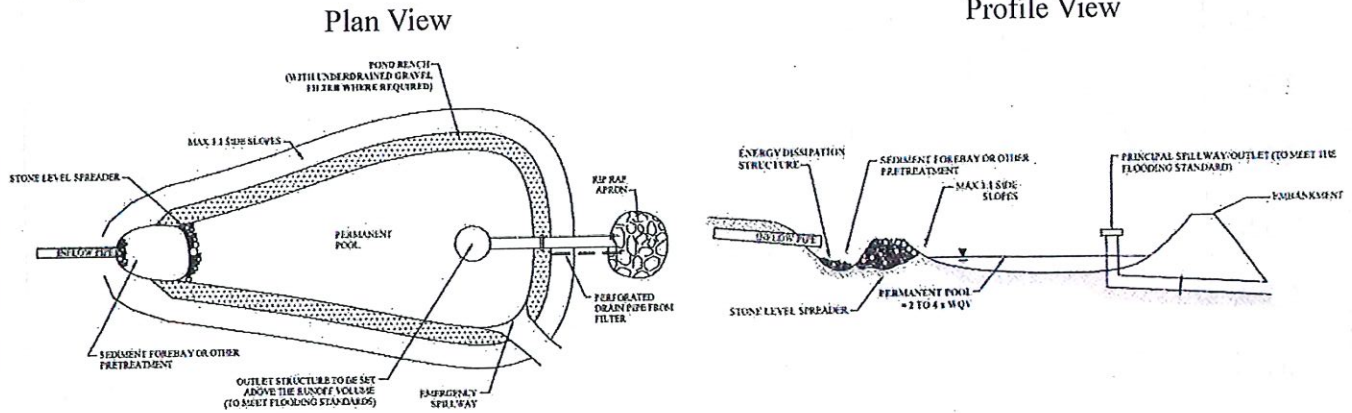

Examples images from the *New Hampshire Stormwater Manual, Volume 2, p. 61*

### Pollutant Export Rate by Land Use<sup>1</sup>

Source Category by Land Use	Land Surface Cover	P Load Export Rate <sup>1</sup> (lbs./acre/year)	N Load Export Rate <sup>2</sup> (lbs./acre/year)
Commercial (COM) and Industrial (IND)	Directly connected impervious	1.78	15
Multi-Family (MFR) and High-Density Residential (HDR)	Directly connected impervious	2.32	14.1
Medium-Density Residential (MDR)	Directly connected impervious	1.96	14.1
Low-Density Residential (LDR) - "Rural"	Directly connected impervious	1.52	14.1

<sup>1</sup> From NH Small MS4 General Permit, Appendix F

### General Equations

Physical Storage Capacity: Depth of Runoff * Drainage Area
Cost: Physical Storage Capacity * Cost Index * Adjustment Factor <sup>1</sup>
Yearly Pollutant Removal: Pollutant Load Export Rate * Drainage Area * Efficiency

### Cost

Infiltration Trench System	Materials and Installation Cost (\$/ft <sup>3</sup> ) (2018)	Design Cost (\$/ft <sup>3</sup> ) (2018)	Total Cost (\$/ft <sup>3</sup> ) (2018) <sup>1,2</sup>
Rural	4.46	2.40	6.86
Mixed	8.92	4.80	13.72
Urban	13.38	7.20	20.58

<sup>1</sup> EPA Memorandum "Methodology for developing cost estimates for Opti-Tool." February 20, 2016  
<sup>2</sup> Converted from 2010 to 2018 dollars using U.S. Department of Labor (USDOL). (2012). Bureau of Labor Statistics consumer price index inflation calculator. [http://www.bls.gov/data/inflation\\_calculator.htm](http://www.bls.gov/data/inflation_calculator.htm)

## BMP Performance Curve for Wet Pond

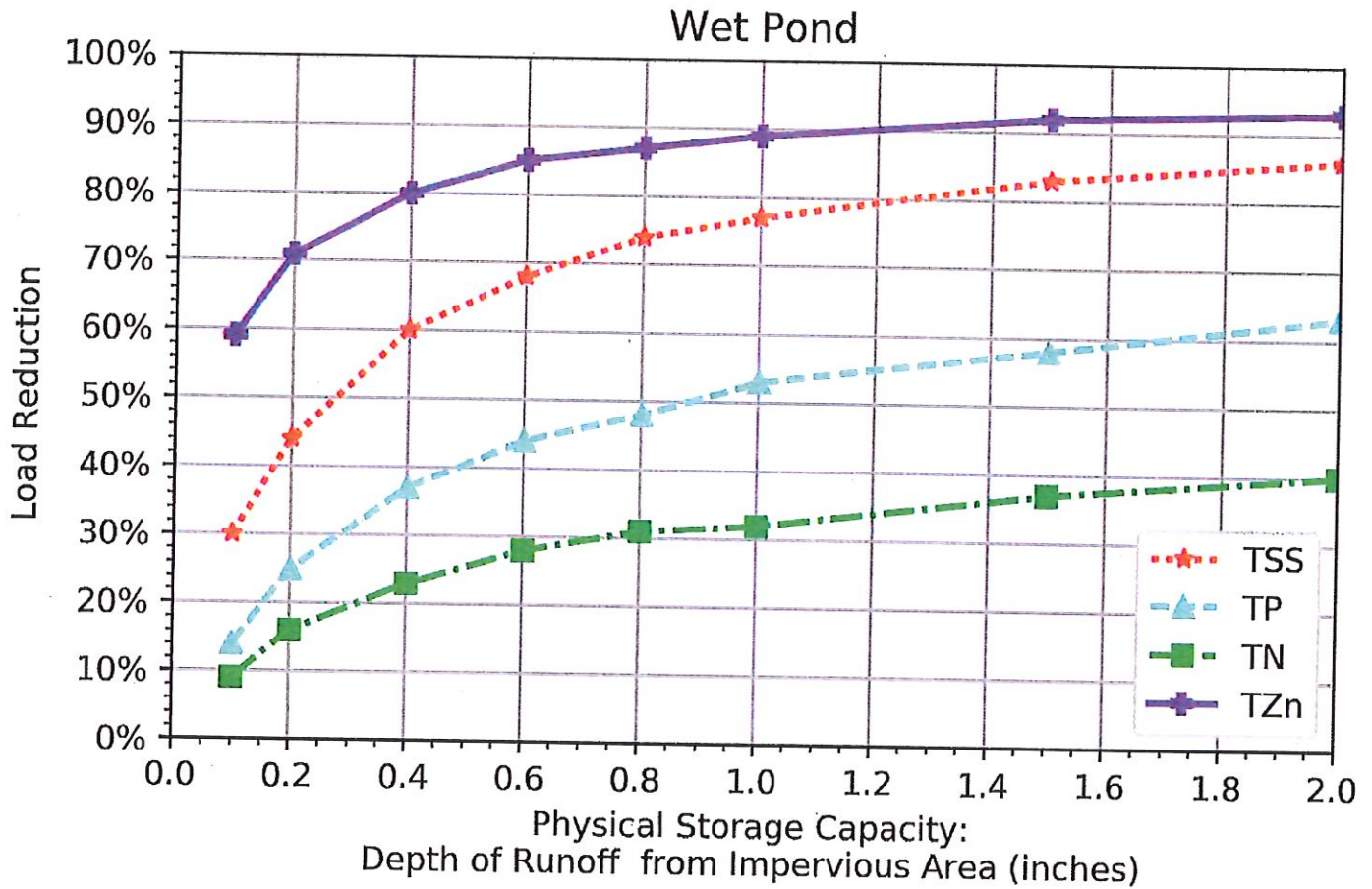

Wet Pond BMP Performance Table								
BMP Capacity: Depth of Runoff from Impervious Area (inches)	0.1	0.2	0.4	0.6	0.8	1.0	1.5	2.0
Cumulative TSS Phosphorus Load Reduction	30%	44%	60%	68%	74%	77%	83%	86%
Cumulative Phosphorus Load Reduction	14%	25%	37%	44%	48%	53%	58%	63%
Cumulative Nitrogen Load Reduction	9%	16%	23%	28%	31%	32%	37%	40%
Cumulative Zinc Phosphorus Load Reduction	59%	71%	80%	85%	87%	89%	92%	93%



## Extended Dry Detention Basin Factsheet

**Detention Basin** consists of a type of system which is primarily intended to provide flood protection by containing the flow within an excavated area and gradually releasing it over the course of a design length of time, with extended dry detention basins typically having a detention time of 24 hours. This reduces the intensity of peak flows, and the detention time allows the treatment of some pollutants, particularly those associated with suspended solids. A detention basin may be combined with other BMPs to combine detention with other treatment methods. Dry detention basins are often referred to as dry ponds, due to their similarity in design to wet ponds. General design specifications for detention basin systems are provided in the most recent version of *The New Hampshire Stormwater Manual, Volume 2: Post-Construction Best Management Practices Selection and Design*.

### Sample Design

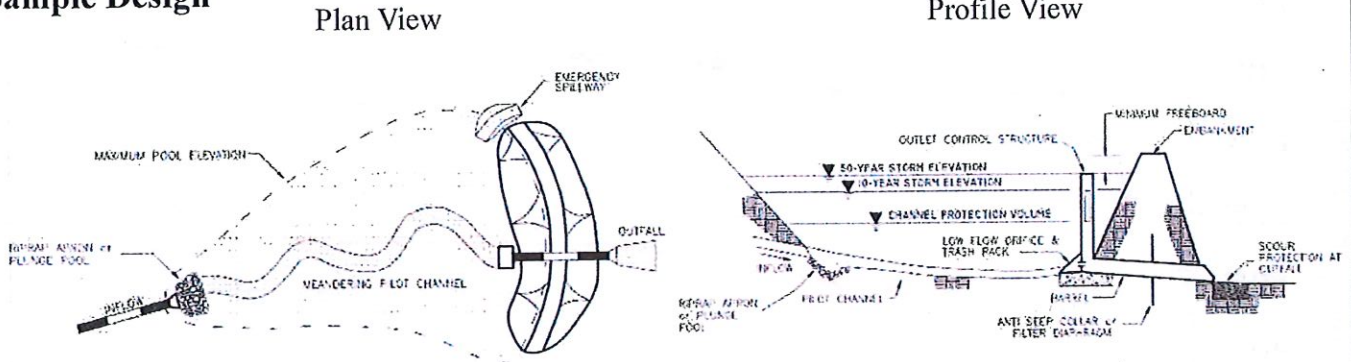

Examples images from the *New Hampshire Stormwater Manual, Volume 2*, p. 159

### Pollutant Export Rate by Land Use<sup>1</sup>

Source Category by Land Use	Land Surface Cover	P Load Export Rate <sup>1</sup> (lbs./acre/year)	N Load Export Rate <sup>2</sup> (lbs./acre/year)
Commercial (COM) and Industrial (IND)	Directly connected impervious	1.78	15
Multi-Family (MFR) and High-Density Residential (HDR)	Directly connected impervious	2.32	14.1
Medium-Density Residential (MDR)	Directly connected impervious	1.96	14.1
Low-Density Residential (LDR) - "Rural"	Directly connected impervious	1.52	14.1

<sup>1</sup> From NH Small MS4 General Permit, Appendix F

### General Equations

Physical Storage Capacity: Depth of Runoff * Drainage Area
Cost: Physical Storage Capacity * Cost Index * Adjustment Factor <sup>1</sup>
Yearly Pollutant Removal: Pollutant Load Export Rate * Drainage Area * Efficiency

### Cost

Infiltration Trench System	Materials and Installation Cost (\$/ft <sup>3</sup> ) (2018)	Design Cost (\$/ft <sup>3</sup> ) (2018)	Total Cost (\$/ft <sup>3</sup> ) (2018) <sup>1,2</sup>
Rural	4.46	2.40	6.86
Mixed	8.92	4.80	13.72
Urban	13.38	7.20	20.58

<sup>1</sup> EPA Memorandum "Methodology for developing cost estimates for Opti-Tool." February 20, 2016

<sup>2</sup> Converted from 2010 to 2018 dollars using U.S. Department of Labor (USDOL). (2012). Bureau of Labor Statistics consumer price index inflation calculator. [http://www.bls.gov/data/inflation\\_calculator.htm](http://www.bls.gov/data/inflation_calculator.htm)

# BMP Performance Curve for Extended Dry Detention Basin

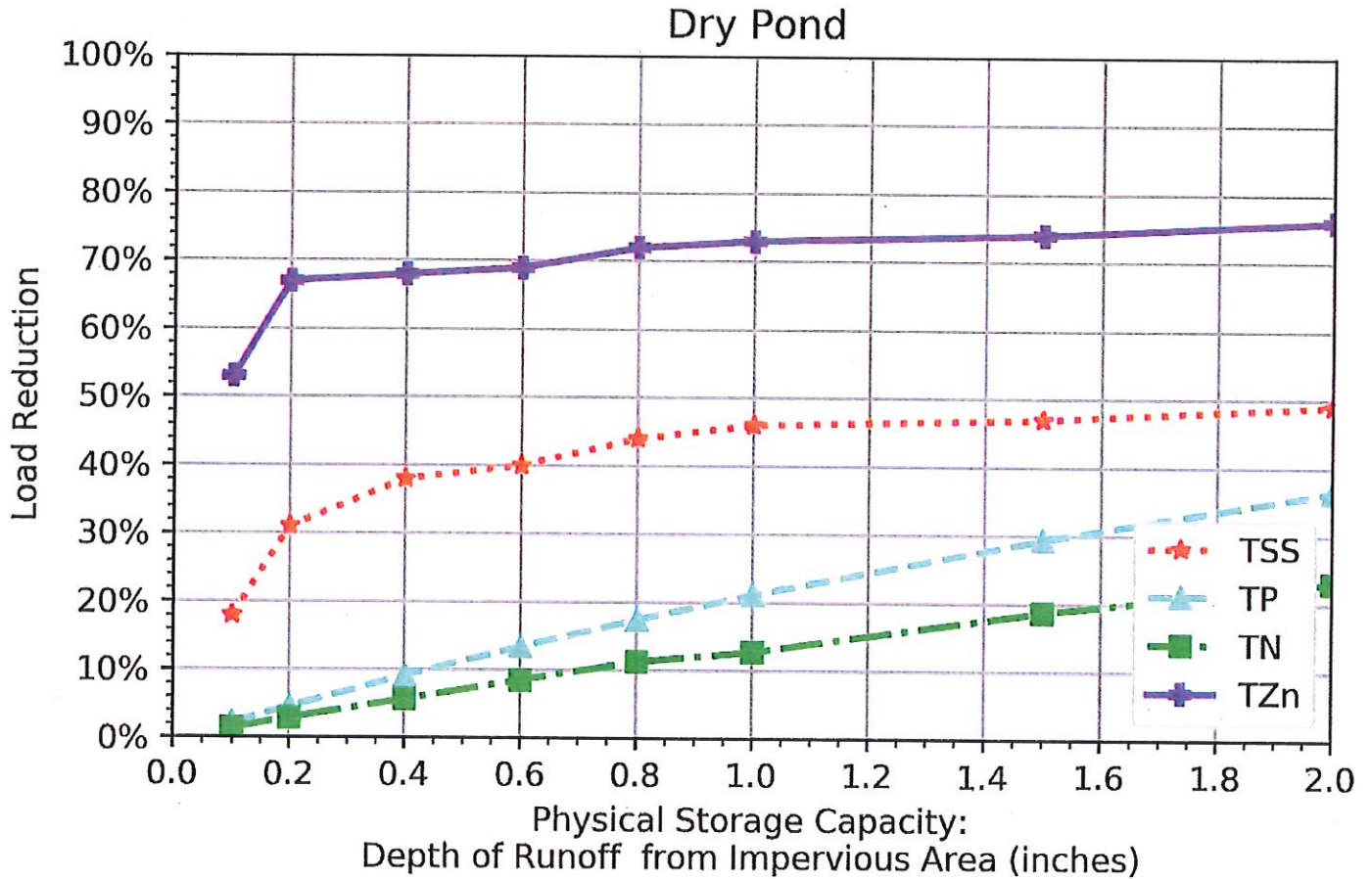

BMP Capacity: Depth of Runoff from Impervious Area (inches)	0.1	0.2	0.4	0.6	0.8	1.0	1.5	2.0
Cumulative TSS Phosphorus Load Reduction	18%	31%	38%	40%	44%	46%	47%	49%
Cumulative Phosphorus Load Reduction	2%	5%	9%	13%	17%	21%	29%	36%
Cumulative Nitrogen Load Reduction	1%	3%	6%	9%	11%	13%	19%	23%
Cumulative Zinc Phosphorus Load Reduction	53%	67%	68%	69%	72%	73%	74%	76%